DOKUMEN SEBUTHARGA

RUJUKAN: _____

**CADANGAN UBAHSUAI RUANG PEJABAT DI TINGKAT 1
CAWANGAN TANJUNG KARANG, SELANGOR UNTUK BANK
SIMPANAN NASIONAL**

Tarikh Taklimat : _____

Tarikh Tutup : Sebelum jam 12.00 Tengah hari

**Peti : Peti Tender ()
Bahagian Perolehan
Tingkat 14, Wisma B.S.N. 117, Jalan Ampang,
50450 KUALA LUMPUR.**

**PROJEK :
CADANGAN UBAHSUAI RUANG PEJABAT DI TINGKAT 1 CAWANGAN TANJUNG KARANG,
SELANGOR UNTUK BANK SIMPANAN NASIONAL**

ISI KANDUNGAN

DOKUMEN SEBUTHARGA

BIL	PERKARA	MUKA SURAT
1	<i>Letter Of Integrity</i>	2 - 3
2	Tawaran Sebutharga dan Syarat Mengemukakan Sebutharga	4 - 5
3	Penerangan dan Arahan Kepada Penyebutharga	5 – 6
4	Syarat – Syarat Am	7 – 12
5	Terma-terma Kesalahan Rasuah	13
6	Lampiran Tidak Bersetuju	14
7	Lampiran Surat Akuan Terima	15
	<u>Dokumen Tawaran Kewangan</u>	
8	Senarai Semak (Cadangan Tawaran Kewangan)	K/1
9	Lampiran A – Borang Sebutharga	K/2 – K/3
10	Lampiran B - Salinan Resit Pembelian Dokumen Sebutharga	K/4
11	Lampiran C - Surat Akuan Pembida	K/5
12	Lampiran D – Perincian Harga/ <i>General Summary</i>	
	<i>i) Final Summary</i>	GST/1
	<i>ii) Bill No. 1 – Preliminaries and General Conditions</i>	SOW/1/1 & GC/4
	<i>iii) Bill No. 2 – Renovation Works</i>	SOW/2/1- SOW/2/2
	<i>iv) Senarai Lukisan</i>	
13	Lampiran E - Borang Maklumat Syarikat	BMS/1 – BMS/4
	<u>Dokumen Tawaran Teknikal</u>	
14	Senarai Semak (Cadangan Tawaran Teknikal)	T/1
15	Jadual Tawaran Teknikal (Pematuhan)	T/2 – T/6
16	Lampiran F - Jadual & Kaedah Perlaksanaan	T/7
17	Lampiran G - Senarai Kakitangan Teknikal	T/8
18	Lampiran H - Senarai Pengalaman Kerja (2 Tahun Terakhir)	T/9
19	Lampiran I - Senarai Kerja/Projek Di Tangan Bagi Tahun Semasa	T/10



Letter of Integrity

Dear Tenderer

As business partners working together successfully and to ensure the highest level of principles, values and standards are met, Bank Simpanan Nasional (BSN) recognizes that improper conduct may arise which will have an impact on our reputation. BSN practices “zero tolerance” towards improper conduct and strive not to place our business partners’ reputation at risk.

This letter outlines the essential elements in maintaining an effective business relationship based on mutual respect and trust. Our Code of Ethics prescribes precise expectations on BSN personnel when dealing with business partners, such as follows:

1. **Gifts** – Albeit that small gifts may be given to our business partners as tokens of appreciation, our Code of Ethics prohibits personnel from directly or indirectly, asking for, receiving from, consenting or agreeing to receiving any gift, commission, emolument, gratuity, money, property, token or of any form whilst transacting or dealing with BSN, in line with our “**No Gift Policy**”.
2. **Entertainment** – Events/programs/meetings associated to entertainment of such form may be necessary to build/strengthen business relationships. Therefore, should you wish to extend such invitation, please forward the invitation to our CE’s Office (for staff) or Chairman’s Office (for Board of Directors), as the case may be.
3. **Member of governing board** – To facilitate impartiality in decision-making, our Code of Ethics outlined strict requirements on personnel’s presence as member of governing board. Declaration would be required from both parties involved to address any biasness that may arise.
4. **Invitations to trips’ abroad** – Invitation to trips are to be referred to the CE’s Office (for staff) or Chairman’s Office (for Board of Directors). BSN personnel are abstained from making actual or apparent commitments formally or informally on behalf of the Bank without proper authorization in accordance with approved procedures and documentation.
5. **Other benefits in kind** – Any benefits received other than those mentioned in items 1-4 are to be referred to the CE’s or Chairman’s Office for review and approval accordingly.
6. **Whistleblowing** – BSN is committed to achieving the highest standards of services and will not tolerate any malpractice or wrongdoing in the administration and delivery. In doing so, we appreciate any report of improper conduct that arises during the course of doing business with our business partners. The whistleblowing form is available at our website www.bsn.com.my/page/whistle-blowing and email to the Integrity Complaint Management (ICM) at whistleblowing_igu@bsn.com.my accordingly.

As our business partner, we recognize and appreciate your contribution to our business success. We realise that business is not simply about addressing short-term cost and commercial considerations, but it's also about establishing and maintaining lasting business relationships based on mutual respect.

We look forward to working together in this regard to uphold our reputation and mutual interests.

1

Yours faithfully,



JAY KHAIRIL JEREMY ABDULLAH

Chief Executive

Bank Simpanan Nasional

1.0 TAWARAN SEBUTHARGA

PROJEK : CADANGAN UBAHSUAI RUANG PEJABAT DI TINGKAT 1 CAWANGAN TANJUNG KARANG, SELANGOR UNTUK BANK SIMPANAN NASIONAL

Adalah dimaklumkan bahawa tuan/puan dipelawa untuk menyertai Sebutharga sebagaimana tersebut di atas.

2.0 SYARAT-SYARAT MENGEMUKAKAN SEBUTHARGA.

- 2.1 Tuan/Puan hendaklah membaca dan memahami syarat-syarat spesifikasi Sebutharga sebelum mengemukakan Sebutharga dan membuat rujukan dengan pihak bank jika terdapat sebarang pertanyaan.
- 2.2 **Dokumen Tawaran Kewangan dan Tawaran Teknikal** hendaklah dimasukkan kedalam **dua (2) sampul surat berasingan dan seterusnya dimasukkan kedalam satu (1) sampul surat utama (lebih besar)** serta perlu **dilabelkan dengan jelas**. Dokumen tawaran dihantar secara serahan tangan atau secara POS **sebelum atau pada jam 12.00 tengahari, hari** bertarikh ke dalam peti Tender yang disediakan, tawaran Sebutharga yang **dikemukakan lewat** dari tarikh dan masa tersebut tidak akan dipertimbangkan.
- 2.3 Bank Simpanan Nasional tidak terikat untuk menawarkan kerja kepada Penyebutharga yang terendah atau lain-lain Penyebutharga.
- 2.4 Bank Simpanan Nasional berhak untuk menangguhkan atau membatalkan Sebutharga ini samada sebahagian atau keseluruhan sebelum atau selepas tarikh tutup Sebutharga tanpa memberikan sebarang alasan terhadap keputusan tersebut. Pihak Bank tidak bertanggungjawab dalam apa jua keadaan untuk membuat sebarang pampasan atau apa-apa bayaran kepada Penyebutharga berkaitan dengan penangguhan atau pembatalan ini.

- 2.5 **Tajuk Sebutharga** dan **tarikh tutup Sebutharga** hendaklah **ditulis** disebelah atas **penjuru kiri sampul surat** dan sila masukkan dokumen Sebutharga didalam peti Tender pada atau sebelum tarikh tutup di alamat berikut :-

Peti Tender ()

Bahagian Perolehan,

Tingkat 14, Wisma B.S.N. 117, Jalan Ampang,

50450 KUALA LUMPUR.

2.6 CONTOH CARA PENGHANTARAN TAWARAN SEBUTHARGA

SAMPUL UTAMA

<p>SULIT</p> <p>No. Sebutharga : xxx/xxx Tajuk Sebutharga : Cad. Tender xxxx Ditutup Pada xx Apr 2018 Jam 12. Tengahari</p>	<p>SULIT</p> <p>No. Sebutharga : xxx/xxx Tajuk Sebutharga/Tender : xxxx DOKUMEN TAWARAN KEWANGAN</p>
<p>Peti Tender () Bhg Perolehan, Tkt. 14, Wisma BSN 117 Jalan Ampang, 50450 Kuala Lumpur</p>	<p>SULIT</p> <p>No. Sebutharga : xxx/xxx Tajuk Sebutharga/Tender : xxxx DOKUMEN TAWARAN TEKNIKAL</p>

3.0 PENERANGAN DAN ARAHAN-ARAHAN KEPADA PENYEBUTHARGA

3.1. Jika mana-mana Penyebutharga :-

- Menarik balik Sebutharganya sebelum tamat tempoh sah Sebutharga atau apa-apa tempoh lanjut, atau
- Mengenakan had, syarat atau janji tambahan selepas tarikh akhir yang ditetapkan bagi penyerahan Sebutharga (dan dalam hal yang sedemikian ianya hendaklah disifatkan sebagai penarikan balik Sebutharga ini), atau
- Jika sekiranya Sebutharga telah disetujuterima, enggan dan tidak melaksanakan Perjanjian Kontrak yang rasmi atau gagal mendeposit Bon Perlaksanaan atau tidak meneruskan kerja-kerja,

maka, dalam mana-mana hal itu, Bank Simpanan Nasional hendaklah, tanpa menyentuh apa-apa hal lain yang ada padanya, sentiasa berhak mengambil tindakan membatalkan pendaftaran Penyebutharga sebagai kontraktor bank atau melaporkan kepada pihak berkuasa sekiranya perlu atau kedua-duanya sekali.

- 3.2. Tiada apa-apa perubahan atau tambahan yang tidak dibenarkan boleh dibuat kepada borang Sebutharga atau mana-mana dokumen Sebutharga yang lain.
- 3.3. Penyebutharga adalah diwajibkan / digalakkan untuk memeriksa bangunan tersebut pada waktu pejabat selepas sesi taklimat Sebutharga untuk memastikan yang mereka faham kerja-kerja yang akan dijalankan sebelum mengisi Borang Sebutharga dan tiada sebarang perubahan atau tambahan harga yang dibenarkan di atas sebarang percanggahan di dalam *Bill Of Quantity* (BQ) dan lukisan tender dan keadaan sebenar di tapak.
- 3.4. Penyebutharga tidak dibenarkan untuk membuat sebarang tuntutan ke atas sebarang percanggahan di dalam *Bill Of Quantity* (BQ) dan lukisan tender dan keadaan sebenar di tapak.
- 3.5. Penyebutharga yang berjaya (jika ada) akan diberitahu tentang Sebutharganya melalui Surat Setuju Terima Tawaran dalam tempoh sah Sebutharga atau apa-apa tempoh lanjutan. Penyebutharga tersebut hendaklah dengan berapa segera yang praktik tetapi sebelum bermulanya kerja-kerja, Penyebutharga perlu menandatangani perakuan terima tawaran (contoh seperti **lampiran Surat Akuan Terima**) dan men deposit dengan Bank, perkara-perkara berikut:-
 - a) Polisi Insurans Tanggungan Awam (iaitu insuran terhadap bencana kepada orang-orang atau kerosakan kepada harta) atau Nota Liputan berserta dengan resit bagi premium yang telah dibayar.
 - b) Polisi Insurans Kerja
 - c) Nombor pendaftaran di bawah Skim Keselamatan Sosial Pekerja (PERKESO) dan/atau Polisi Insurans Pampasan Pekerja bagi pekerja yang tidak termasuk di bawah Skim PERKESO
- 3.6. Semua butir-butir di dalam jadual yang dilampirkan bersama Borang Tawaran Sebutharga (Kewangan & Teknikal) hendaklah diisi dan diserahkan dengan lengkap.
- 3.7. Maklumbalas kepada dokumen Sebutharga mestilah ditandatangani oleh individu didalam organisasi yang mempunyai kuasa (Pengarah Urusan / Pengarah) untuk mematuhi semua maklumat yang dinyatakan dan perincian jawatan perlu dinyatakan.
- 3.8. Tiap-tiap notis kepada Penyebutharga akan diposkan ke alamat yang dinyatakan di dalam borang tawaran Sebutharga dan pengiriman tersebut hendaklah disifatkan penyampaian yang sempurna akan notis itu.
- 3.9. Perkataan-perkataan 'Penyebutharga berjaya' hendaklah dimengertikan sebagai Penyebutharga yang mana sebutharganya telah diluluskan dan disetujui terima oleh Pengurusan Bank.
- 3.10. Perkataan 'Penyebutharga' dalam syarat-syarat ini hendaklah disifatkan sebagai termasuk dua orang atau lebih.
- 3.11. Jika Penyebutharga tidak mematuhi mana-mana syarat yang tersebut di atas mengenai apa jua hal maka ini boleh menyebabkan Sebutharganya ditolak.
- 3.12. Arahan-arahan Sebutharga ini, setakat mana ianya mungkin menyentuh pelaksanaan kontrak ini, hendaklah disifatkan menjadi sebahagian daripada kontrak ini.

4.0 SYARAT-SYARAT AM

Tarikh Kontrak Dibuat	
No. Sebutarga	
Nama Kontrak	CADANGAN UBAHSUAI RUANG PEJABAT DI TINGKAT 1 CAWANGAN TANJUNG KARANG, SELANGOR UNTUK BANK SIMPANAN NASIONAL
Tempoh Kontrak	
Harga Kontrak	

4.1. PEMBAYARAN

- a) Dengan cek setelah menerima bahan diatas dalam keadaan sempurna serta pemulangan semua artwork / filem / contoh seperti yang disyaratkan. **Pesanan Belian asal** hendaklah dikemukakan ke Jabatan Kewangan bersama **inbois** dan **nota hantaran** untuk **proses pembayaran**.
- b) Pihak Bank berhak mengenakan wang tahanan / potongan harga sekiranya pihak syarikat gagal sempurnakan kerja-kerja mengikut syarat-syarat dalam spesifikasi atau lewat menyiapkan kerja-kerja berdasarkan tempoh yang ditetapkan dalam arahan kerja. Seperti dilampiran berikut.

4.2. PENOLAKAN

- a) Mana-mana syarikat yang telah mengambil borang / Sebutarga tetapi memutuskan untuk tidak menyertai cadangan kerja ini hendaklah memaklumkan secara bertulis kepada Bahagian Perolehan sebagaimana format dilampiran pada atau sebelum tarikh tutup.
- b) **Dokumen Sebutarga yang kurang lengkap dan tidak mengikut spesifikasi tidak akan diberi pertimbangan.**

4.3. RINGKASAN TAWARAN

- a) Ringkasan tawaran hendaklah diisi dengan lengkap, ditandatangani dan dikemukakan bersama-sama dengan borang Sebutarga. Harga untuk mana-mana butiran yang tidak diisi dan juga perkara-perkara yang tidak disenaraikan didalam Ringkasan tawaran tetapi diperlukan dan dapat disimpulkan dari penentuan kerja atau spesifikasi Sebutarga adalah dianggap telah termasuk kedalam Sebutarga.
- b) Ringkasan Tawaran hendaklah menjadi sebahagian daripada Borang Sebut Harga ini dan hendaklah menjadi asas Jumlah Sebut Harga.
- c) Tiada sebarang tuntutan akan dilayan bagi pelarasan harga akibat daripada perubahan kos kerajaan, sama ada dalam tempoh sah sebut harga atau dalam tempoh perkhidmatan

4.4. JUMLAH HARGA SEBUTHARGA

- a) Jumlah sebut harga ialah jumlah harga yang dicatatkan di dalam Borang Tawaran Sebut Harga kerja atau lain-lain jumlah yang dibenarkan menurut syarat-syarat sebut harga ini.
- b) Jika terdapat perbezaan di antara jumlah di dalam Ringkasan Sebut Harga dengan jumlah yang dibawa ke Borang Sebutharga maka jumlah harga sebut harga yang akan diambilkira ialah jumlah yang dinyatakan di dalam Borang Sebutharga tersebut. Sekiranya berlaku kesilapan antara jumlah perkataan dengan jumlah berangka maka jumlah perkataan hendaklah diambilkira.

4.5. PENGELUARAN / PELAKSANAAN KERJA

- a) Sebut harga/tender yang berjaya akan dikeluarkan melalui surat tawaran Bank Simpanan Nasional selepas kelulusan sebut harga/tender Bank Simpanan Nasional.

4.6. TEMPOH SIAP KERJA

- a) Kerja-kerja hendaklah disiapkan seberapa segera yang mungkin. Oleh itu kontraktor dinasihatkan supaya berhati-hati didalam menentukan tempoh siap kerja.
- b) Denda sebanyak **RM 100.00** / hari akan dikenakan diatas kelewatan menyiapkan kerja selepas tarikh yang dibenarkan mengikut kadar yang termaktub di dalam kontrak.

4.7. BON PELAKSANAAN

- a) Bagi kontrak kerja, kontraktor hendaklah mengemukakan seperti berikut :
 - i. Bagi kontrak yang bernilai melebihi RM20,000 sehingga RM300,000, wang tahanan sebanyak 5% akan dikenakan sebagai jaminan tempoh kecacatan.
 - ii. Bagi kontrak yang bernilai melebihi RM300,000, kontraktor hendaklah mengemukakan Bon Pelaksanaan sebanyak 5% dari harga kontrak atau dikenakan Wang Jaminan Pelaksanaan (WJP), jika gagal mengemukakan Bon Pelaksanaan sebelum kerja dibuat.

4.8. JADUAL KERJA

Syarikat yang berjaya hendaklah mengemukakan /memaklumkan jadual kerja dalam tempoh 14 hari daripada menerima Surat Tawaran daripada Pihak Bank yang menunjukkan jadual kerja yang menunjukkan rancangan kerjanya adalah munasabah dan selaras dengan tempoh siap kerja yang ditawarkan.

4.9. PERMULAAN KERJA

- a) Syarikat hendaklah memulakan kerja dalam tempoh SEGERA dari tarikh surat arahan kerja dikeluarkan dikeluarkan.
- b) Sekiranya syarikat gagal untuk memulakan kerja dalam tempoh arahan kerja, surat tawaran akan dibatalkan serta syarikat akan ditahan dari menyertai

mana-mana kerja Sebutharga selanjutnya dan tindakan mengesyorkan menggantung pendaftaran akan dibuat.

- c) Pihak Bank juga berhak mengubah tempoh atau tarikh mula kerja yang sepatutnya sekiranya terdapat kerja-kerja yang perlu disegerakan.

4.10. PEMILIHAN SEBUTHARGA

- a) Bank Simpanan Nasional tidak boleh terikat menerima Sebutharga yang terendah sekali atau sesuatu Sebutharga dan juga tidak terikat untuk memberi apa-apa sebab atas penolakan sesuatu Sebutharga.
- b) Pihak Bank berhak untuk melantik syarikat yang berlainan untuk setiap item.

4.11. TEMPOH KUATKUASA SEBUTHARGA

Tempoh kuatkuasa Sebutharga ini ialah selama 90 hari dari tarikh tutup Sebutharga.

4.12. LAIN-LAIN

- a) Pihak Bank berhak menolak penerimaan mana-mana kerja diatas yang didapati kurang memuaskan serta tidak mengikut spesifikasi. Juga, penalti boleh dikenakan keatas mana-mana kontraktor yang tidak membuat kerja tersebut dalam jangka masa yang telah ditetapkan oleh Bank.
- b) Pihak kontraktor hendaklah bersedia untuk membuat sebarang pindaan ke atas kerja ini sekiranya berlaku perubahan baru keatas formatnya tanpa tambahan kos.
- c) Kerja yang telah dibuat tetapi mengalami kerosakan akibat tidak menepati spesifikasi hendaklah dibuat semula oleh pihak kontraktor.
- d) Kontraktor yang tidak mematuhi syarat-syarat di dalam dokumen sebutharga ini boleh disenarai hitamkan dari menyertai mana-mana tender BSN.
- e) Pihak kontraktor juga bersetuju, jika sebutharga ini disetujuterima untuk:-
 - i. Mendeposit dengan seberapa segera yang praktik selepas penerimaan Surat Setuju Terima Tawaran sebutharga tetapi sebelum bermulanya kerja-kerja, perkara-perkara berikut :-
 - Polisi Insurans Tanggungan Awam (iaitu insurans terhadap bencana kepada orang-orang dan kerosakan kepada harta) atau Nota Liputan beserta dengan resit bagi premium yang telah dibayar.
 - Polisi Insurans Kerja
 - Nombor pendaftaran di bawah Skim Keselamatan Sosial Pekerja (PERKESO) dan/atau Polisi Insurans Pampasan Pekerja bagi pekerja yang tidak termasuk di bawah Skim PERKESO
 - ii. Memastikan pembekalan peralatan yang cukup dan pekerja menggunakan peralatan yang sesuai bagi menjalankan kerja mengikut keperluan semasa termasuk mesin, tangga, papantanda, 'barries' dan lain-lain keperluan.

- iii. Semua mesin yang digunakan adalah tertakluk kepada peraturan dan undang-undang berikut :-
 - Standard and Industrial Research Institute Of Malaysia (SIRIM)
 - Electrical Inspectorate Act 1983 (Act 277) and Electrical Inspectorate Regulation.
 - Factory and Machinery Act 1967 (Act 139) and Regulation and Rules.
 - Factory and Machinery (Building Operational and Works of Engineering Construction) Regulation 1986.
 - iv. Segala peralatan dan bahan *chemical* tidak akan menyebabkan kerosakan terhadap harta benda Bank. Sekiranya berlaku kerosakan, maka Bank berhak untuk membuat tuntutan bagi membaiki/membeli yang baru.
 - v. Tidak merosakkan peralatan Bank semasa menjalankan kerja. Sebarang kerosakan yang dilakukan dengan sengaja atau tidak sengaja oleh pekerja-pekerja hendaklah diperbaiki/diganti oleh pihak tuan/puan. Sekiranya kontraktor gagal berbuat demikian selepas tamat tempoh yang diberikan, maka Bank berhak memanggil syarikat lain untuk memperbaiki/pembekalan baru dibuat dan segala kos akan ditolak dari sebarang Bayaran kepada pihak kontraktor terlibat.
 - vi. Tuan tidak boleh menyerahhak, melantik sub-kontraktor atau “novate” tanggungjawab-tanggungjawab tuan di bawah Surat Tawaran ini atau mana-mana bahagian Kerja-kerja kecuali setelah mendapat kebenaran secara bertulis daripada kami. Bank berhak untuk membatalkan Surat Tawaran atau kontrak ini sekiranya Tuan melanggar peruntukan ini. Untuk mengelakkan keraguan serahanhak meliputi penggunaan sepenuhnya tenaga kerja pihak ketiga bagi ('Sub labour') dan barangan/perkhidmatan ('Sub trade') tanpa kebenaran bertulis pihak Bank.
 - vii. Kontraktor wajib melantik seorang penyelia tapak dari kontraktor utama yang bertanggungjawab sepenuhnya dengan kerja yang dijalankan dan mestilah boleh dihubungi pada setiap masa oleh pihak BSN. BSN berhak untuk menghentikan kerja dan membatalkan kontrak sekiranya didapati kontraktor melantik sub kontraktor sebagai wakil syarikat.
 - viii. Kontraktor dikehendaki mengemukakan maklumat pekerja (nama, alamat, no kerja permit/kad pengenalan) kepada bank dan setiap kali terdapat pertukaran pekerja.
 - ix. Pihak Bank berhak melantik Pihak Ketiga untuk melaksanakan baki kontrak jika pihak syarikat gagal melaksanakan keseluruhan baki kontrak atau tidak menyiapkan kerja dengan tidak memuaskan tanpa sebab-sebab yang boleh diterima seperti yang termaktub selepas Surat Peringatan Ketiga/Terakhir dikeluarkan oleh Pihak Bank dan pembayaran akan ditolak dari amaun Kontrak.
- f) Membuat tuntutan dengan mengemukakan bil / Inbois dan DO terhadap kerja-kerja yang telah disiapkan kepada Bank untuk diproses bayaran bersama Pesanan Belian / Kontrak Perjanjian.

- g) Semua kerja-kerja yang dijalankan adalah tertakluk kepada Akta Keselamatan dan Kesihatan Pekerjaan 1994 (AKKP1994) dan peraturan-peraturannya, Suruhan Jaya Tenaga, Akta Bekalan Elektrik, IEE, Sirim dan lain-lain pihak berkuasa.
- h) Tempoh kecacatan bagi sesuatu kerja-kerja ubahsuai/baikpulih adalah dari tarikh serah tapak seperti berikut :
- | | | |
|-----|---|----------|
| i. | Harga kontrak RM10,000.00 – RM50,000.00 | 6 bulan |
| ii. | Harga kontrak melebihi RM50,000.00 | 12 bulan |
- i) Pihak Pembekal/Petender dengan ini juga bersetuju bahawa borang sebutharga ini berserta Surat Setuju Terima Sebutharga ini, hendaklah menjadi kontrak yang mengikat Bank Simpanan Nasional dengannya walaupun Perjanjian Kontrak yang rasmi belum dilaksanakan.
- j) Yang bertandatangan di bawah tawaran sebutharga ini bersetuju bahawa :
- Jika sebutharga ini ditarik balik sebelum tamat tempoh sah sebutharga atau apa-apa tempoh lanjutan, atau
 - Mengenakan apa-apa had, syarat atau janji tambahan kepada sebutharga ini selepas tarikh akhir yang ditetapkan bagi penyerahan sebutharga, atau
 - Enggan atau tidak melaksanakan perjanjian kontrak yang rasmi atau tidak meneruskan kerja-kerja;-
Maka, dalam mana-mana hal itu, tanpa menyentuh apa-apa hak lain yang ada padanya, Bank Simpanan Nasional adalah berhak mengambil tindakan yang padanya, Bank Simpanan Nasional adalah berhak mengambil tindakan yang sewajarnya yang difikirkan perlu terhadap yang bertandatangan di bawah ini.
 - Bank berhak untuk menawarkan satu skop kerja saja / melebihi satu skop kerja tanpa memberi alasan tidak ditawarkan skop kerja yang tertentu.
 - Bank berhak untuk menamatkan semua perkhidmatan yang ditawarkan atau sebahagian perkhidmatan yang ditawarkan dengan memberi notis tempoh 30 hari kepada yang bertandatangan di bawah ini tanpa memberi sebarang alasan/penjelasan mengenai penamatan perkhidmatan ini sebelum tamat tempoh perjanjian yang telah ditandatangani.
 - Memberi jaminan selama 3 bulan bagi setiap alat ganti yang telah ditukar & segala pemasangan / penyelenggaraan kerja elektrik yang dijalankan perlu mengikut peraturan Suruhanjaya Tenaga, Akta Bekalan Elektrik, IEE, SIRIM & lain-lain Pihak Berkuasa dalam perkara ini.
- k) Yang bertandatangan di bawah ini bersetuju bahawa perlulah mematuhi perkara 23 Orang-Orang Yang Menjaga (Akta Bekalan Elektrik 1990 (Akta 447)
- Tiada pemasangan atau loji atau kelengkapan elektrik selain daripada yang dipunyai atau diuruskan oleh pihak berkuasa bekalan boleh dikerjakan atau dikendalikan kecuali oleh atau di bawah kawalan orang-orang yang memiliki apa-apa perakuan sebagaimana yang

ditetapkan, dan tiada seorang pun yang tidak memiliki kelayakan atau memegang perakuan seperti disebut terdahulu boleh menjaga apa-apa pemasangan atau boleh mengawal pengendalian apa-apa loji atau kelengkapan elektrik.

- (ii) Pada setiap helaian **Dokumen Tawaran Teknikal**, semua penender **DILARANG SAMA SEKALI** untuk menyatakan sebarang pengenalan syarikat (Cop Syarikat, *Letterhead*, Salinan Sijil yang mempunyai nama syarikat).
- (iii) **Jika didapati pelanggaran terhadap mana-mana syarat yang dinyatakan, Bank berhak untuk menolak tawaran yang dikemukakan.**

Dengan disaksikan pihak-pihak di sini telah menandatangani Kontrak ini pada tarikh seperti di halaman 7 di atas.

Ditandatangani untuk dan bagi

Ditandatangani untuk dan bagi

Kontraktor :

BSN:

.....

.....

(Tandatangan)

(Tandatangan)

Nama :

Nama :

Jawatan :

Jawatan :

No.Kad Pengenalan :

No. Kad Pengenalan:

di hadapan saksi:

.....

.....

(Tandatangan)

(Tandatangan)

Nama :

Nama :

Jawatan :

Jawatan :

No.Kad Pengenalan:

No.Kad Pengenalan

5.0 TERMA-TERMA KESALAHAN RASUAH

- a) Sebarang perbuatan atau percubaan rasuah untuk menawar atau memberi, memberi meminta atau menerima apa-apa suapan secara rasuah kepada dan daripada mana-mana orang berkaitan perolehan ini merupakan satu kesalahan jenayah di bawah Akta Suruhanjaya Pencegahan Rasuah 2009 (Akta 694) .

Any act or attempt to corruptly offer or give, solicit or receive any gratification to and from any person in connection with this procurement is a criminal offence under the Malaysian Anti-Corruption Commission Act 2009 (Act 694).

- b) Sekiranya mana-mana pihak ada menawarkan atau memberi apa-apa suapan kepada mana-mana anggota pentadbiran awam, maka pihak yang ditawarkan atau diberi suapan dikehendaki membuat aduan dengan segera ke pejabat Suruhanjaya Pencegahan Rasuah Malaysia atau balai polis yang berhampiran. Kegagalan berbuat demikian adalah merupakan satu kesalahan di bawah Akta Suruhanjaya Pencegahan Rasuah 2009 (Akta 694)

If any person offers or gives any gratification to any members of public service, the latter shall at the earliest opportunity thereafter lodge a report at the nearest office of the Malaysian Anti Corruption Commission Agency or police station. Failure to do so is an offence under the Malaysian Anti-Corruption Commission Act 2009 (Act 694).

- c) Tanpa prejudis kepada tindakan-tindakan lain, tindakan tatatertib terhadap anggota perkhidmatan awam dan menyenaraihitamkan kontraktor atau pembekal boleh diambil sekiranya pihak-pihak terlibat dengan kesalahan rasuah di bawah Akta Suruhanjaya Pencegahan Rasuah 2009 (Akta 694).

Without prejudice to any other actions, disciplinary action against a member of the public service and blacklisting of the contractor or supplier may be taken if the parties are involved with any act of corruption under the Malaysian Anti-Corruption Commission Act 2009 (Act 694).

- d) Mana-mana kontraktor atau pembekal yang membuat tuntutan bayaran berkaitan perolehan ini walaupun tiada kerja dibuat atau tiada barangan dibekal mengikut spesifikasi yang ditetapkan atau tiada perkhidmatan awam yang mengesahkan tuntutan berkenaan adalah melakukan kesalahan di bawah Akta Suruhanjaya Pencegahan Rasuah 2009 (Akta 694).

Any contractor or supplier who makes a claim for payment in relation to this procurement although no work as carried out or no goods were supplied or no services rendered in accordance with specifications and any member of the public service who certifies the claim commits an offence under the Malaysian Anti-Corruption Commission Act 2009 (Act 694).

Lampiran Tidak Bersetuju

No. Sebutharga : _____

Ketua,
Bahagian Perolehan

Bank Simpanan Nasional
Tingkat 14, Wisma BSN
117 Jalan Ampang,
50450 Kuala Lumpur.

Tuan,

**CADANGAN UBAHSUAI RUANG PEJABAT DI TINGKAT 1 CAWANGAN TANJUNG KARANG,
SELANGOR UNTUK BANK SIMPANAN NASIONAL**

Dengan hormatnya perkara diatas adalah dirujuk.

Pihak kami mengesahkan bahawa pihak kami tidak bersetuju untuk menyertai Sebutharga bagi cadangan kerja sebagaimana di atas kerana _____

Sekian, terima kasih.

Nama syarikat : _____

Nama Pegawai yang diberikuasa : _____

Jawatan : _____

Tandatangan : _____

Tarikh : _____

Lampiran Surat Akuan Terima

No. Sebutharga : _____

Ketua

Bahagian Perolehan

Bank Simpanan Nasional

Tingkat 14, Wisma BSN

117, Jalan Ampang

50450, Kuala Lumpur

Tuan,

SURAT AKUAN TERIMA

Kami, _____ dengan ini tanpa syarat dan tidak menarik balik, menerima terma-terma dan syarat - syarat dalam Surat Tawaran SetujuTerima bagi **CADANGAN UBAHSUAI RUANG PEJABAT DI TINGKAT 1 CAWANGAN TANJUNG KARANG, SELANGOR UNTUK BANK SIMPANAN NASIONAL** yang bertarikh pada - _____ ini.

Bersama ini juga, kami sertakan SURAT AKUAN PEMBIDA BERJAYA yang telah diisi dan ditandatangani oleh wakil syarikat yang diberi kuasa. Dilampirkan juga Surat Perwakilan Kuasa menandatangani bagi pihak syarikat sebagai bukti pengesahan.

Sekian, terima kasih.

Nama Syarikat : _____

No. Pendaftaran : _____

Cop Syarikat : _____

Nama Pegawai : _____
yang diberi kuasa

Jawatan : _____

Tandatangan : _____

Tarikh : _____

DOKUMEN TAWARAN KEWANGAN

RUJUKAN: _____

**CADANGAN UBAHSUAI RUANG PEJABAT DI TINGKAT 1
CAWANGAN TANJUNG KARANG, SELANGOR UNTUK BANK
SIMPANAN NASIONAL**

Tarikh Tutup : Sebelum jam 12.00 Tengah hari

**Peti : Peti Tender ()
Bahagian Perolehan
Tingkat 14, Wisma B.S.N. 117, Jalan Ampang,
50450 KUALA LUMPUR.**

SENARAI SEMAK

Sila tandakan / Bagi Dokumen-dokumen Yang Disertakan.

Bil.	Perkara / Dokumen	Untuk Ditanda Oleh Syarikat	Untuk Ditanda Oleh Jawatankuasa Pembuka Sebutharga
1.	Lampiran A – Borang Sebutharga*	<input type="checkbox"/>	<input type="checkbox"/>
2.	Lampiran B – Salinan Resit Pembelian Dokumen Sebutharga*	<input type="checkbox"/>	<input type="checkbox"/>
3.	Lampiran C – Surat Akuan Pembida*	<input type="checkbox"/>	<input type="checkbox"/>
4.	Lampiran D – <i>General Summary</i> *	<input type="checkbox"/>	<input type="checkbox"/>
5.	Lampiran E – Borang Maklumat Syarikat	<input type="checkbox"/>	<input type="checkbox"/>
	i. Profil Syarikat*	<input type="checkbox"/>	<input type="checkbox"/>
	ii. Salinan Sijil Pendaftaran dengan Kementerian Kewangan (jika berkaitan)	<input type="checkbox"/>	<input type="checkbox"/>
	iii. Salinan Sijil Pendaftaran sebagai syarikat Bumiputera (jika berkaitan)	<input type="checkbox"/>	<input type="checkbox"/>
	iv. Salinan Sijil Pendaftaran CIDB*	<input type="checkbox"/>	<input type="checkbox"/>
	v. Salinan Sijil Pendaftaran Syarikat (SSM) yang sah*	<input type="checkbox"/>	<input type="checkbox"/>
	vi. Salinan surat sebagai pengedar dan pembekal yang sah dan salinan perjanjian di antara penyebutharga dengan pengedar/pembekal bagi setiap produk yang dicadangkan (jika berkaitan)	<input type="checkbox"/>	<input type="checkbox"/>
	vii. Salinan penyata bank terkini (3 bulan) yang disahkan oleh pihak Bank* (Sila pastikan baki akhir dinyatakan dengan jelas)		
	a. Disahkan oleh pihak Bank	<input type="checkbox"/>	<input type="checkbox"/>
	b. Tidak disahkan oleh pihak Bank	<input type="checkbox"/>	<input type="checkbox"/>
	c. Tidak dikemukakan	<input type="checkbox"/>	<input type="checkbox"/>
	viii. Pengesahan kemudahan kredit / Borang <i>Credit Analysis</i> (CA) (jika ada)	<input type="checkbox"/>	<input type="checkbox"/>

Nota: Penilaian tidak akan dijalankan ke atas penyebutharga yang gagal mengemukakan dokumen yang bertanda (*)

LAMPIRAN A

BORANG SEBUTHARGA

Kepada :

Peti Sebutharga
Bahagian Perolehan
Tingkat 14, Wisma B.S.N.
117, Jalan Ampang,
50450 KUALA LUMPUR.

SEBUT HARGA :

CADANGAN UBAHSUAI RUANG PEJABAT DI TINGKAT 1 CAWANGAN TANJUNG KARANG, SELANGOR UNTUK BANK SIMPANAN NASIONAL

Setelah meneliti borang sebutharga dan spesifikasi sebutharga, saya/kami dengan ini memberikan sebutharga bagi menjalankan kerja-kerja mengikut sebagaimana penentuan yang bernilai ;

RINGGIT MALAYSIA: _____
()

Kiranya saya/kami dilantik ;

- a) Saya/Kami akan memulakan kerja dalam masa 7 hari dari tarikh perintah kerja dikeluarkan atau pesanan belian dan akan menyiapkan kerja-kerja tersebut dalam tempoh 2 minggu.
- b) Sebutharga saya/kami akan sah dalam masa sembilan puluh (90) hari dari tarikh tutup sebutharga.
- c) Saya/Kami bersetuju bahawa tidak semestinya sebutharga terendah diterima.
- d) Saya/Kami bersetuju akan mematuhi segala syarat-syarat am dan lain-lain syarat sepertimana yang dinyatakan didalam dokumen sebutharga ini.

Tandatangan : _____

Nama :

No K.P :

Tarikh :

Cop Syarikat :

Tandatangan Syarikat :.....

Nama Penender :.....

Nama Syarikat :.....

Alamat :.....

.....

.....

Tarikh :.....

Tandatangan saksi :.....

Nama :.....

Alamat :.....

.....

.....

LAMPIRAN B

SALINAN RESIT PEMBELIAN DOKUMEN SEBUTHARGA

Sila lekatkan resit pembelian dokumen sebutharga disini.

SURAT AKUAN PEMBIDA
Bagi

**CADANGAN UBAHSUAI RUANG PEJABAT DI TINGKAT 1 CAWANGAN TANJUNG KARANG,
SELANGOR UNTUK BANK SIMPANAN NASIONAL**

Saya, (Nama Wakil Syarikat) _____ no K.P
_____ yang mewakili (Nama Syarikat) _____
nombor Pendaftaran (MOF/PKK/CIDB/ROS/ROC/ROB) _____

dengan ini mengisytiharkan bahawa saya atau mana-mana individu yang mewakili syarikat ini tidak akan menawar atau memberi rasuah kepada mana-mana individu dalam Bank Simpanan Nasional atau mana-mana individu lain, sebagai sogokan untuk dipilih dalam tender seperti di atas. Bersama-sama ini dilampirkan Surat Perwakilan Kuasa saya mewakili syarikat seperti yang tercatat di atas untuk membuat pengisytiharan ini.

2. Sekiranya saya atau mana-mana individu yang mewakili syarikat ini didapati cuba menawar atau memberi rasuah kepada mana-mana individu dalam Bank Simpanan Nasional atau mana-mana individu lain sebagai sogokan untuk dipilih dalam sebutharga seperti di atas, maka saya sebagai wakil syarikat bersetuju tindakan-tindakan berikut diambil:

- 2.1 Penarikan balik tawaran kontrak bagi sebutharga di atas; atau
- 2.2 Penamatan kontrak bagi sebutharga di atas; dan
- 2.3 Lain-lain tindakan tatatertib mengikut peraturan perolehan Bank Simpanan Nasional yang berkuat-kuasa.

3. Sekiranya terdapat mana-mana individu cuba meminta rasuah daripada saya atau mana-mana individu yang berkaitan dengan syarikat ini sebagai sogokan untuk dipilih dalam sebutharga seperti di atas, maka saya berjanji akan dengan segera melaporkan perbuatan tersebut kepada pejabat Suruhanjaya Pencegahan Rasuah Malaysia (SPRM) atau balai polis yang berhampiran.

Yang Benar,

Nama :

No K.P :

Cop Syarikat :

Catatan : *Potong mana yang tidak berkaitan.

LAMPIRAN D

**PERINCIAN HARGA/
GENERAL SUMMARY**

BILL OF QUANTITIES
FINAL SUMMARY

LAMPIRAN D

FINAL SUMMARY

ITEM	DESCRIPTION	FROM PAGE NO.	AMOUNT (RM)
	GENERAL SUMMARY		
A	BILL NO.1 : PRELIMINARIES AND GENERAL CONDITIONS	SOW/1/5	
B	BILL NO.2 : RENOVATION WORKS	SOW/2/2	
	JUMLAH HARGA		
	SST (Rujuk Nota di bawah)		
	JUMLAH HARGA KESELURUHAN TERMASUK SST		

Nota:

1. Sekiranya dikenakan SST, sila NYATAKAN jumlah SST di jadual di atas
2. Sekiranya tidak dikenakan SST, sila NYATAKAN (N/A) di jadual di atas
3. Sekiranya SST tidak dinyatakan, Jumlah Keseluruhan adalah dianggap telah termasuk SST

Ringgit Malaysia : _____

SIGNATURE OF CONTRACTOR

SIGNATURE OF WITNESS

NAME IN FULL

NAME IN FULL

CAPACITY

CAPACITY

OFFICIAL STAMP

DATE :

BILL OF QUANTITIES

**BILL NO.1- PRELIMINARIES AND
GENERAL CONDITION**

PRELIMINARIES

Item	Description	Unit	Qty	Rate (RM)	Amount (RM)
	<u>PRELIMINARIES</u>				
A	<p>REMOVAL OF RUBBISH</p> <p>The Contractor is to keep the site and buildings, adjacent roads and footpaths etc. clean during the progress of the works and periodically cart away all dirt, building rubbish and superfluous materials as the work proceeds and on completion. Rubbish bin erected shall be structurally sound and maintained in a safe condition. The Contractor shall liaise with Local Authority for the rental of roro.</p>	LS			
B	<p>AS BUILT DRAWINGS AND OPERATING AND MAINTENANCE INSTRUCTIONS</p> <p>The Contractor shall prepare, and shall cause his Sub-Contractors to prepare, "As-Built" drawings indicating actual locations and levels of the completed works. Unless otherwise specified the Contractor shall submit a copy of As Built Drawing in CD and three sets of As-Built drawings in A3 size.</p> <p>As-Built drawing shall consist of layout plan for:</p> <ul style="list-style-type: none"> i) Partition, door and window schedule ii) Floor finishes iii) Reflected ceiling, lighting & aircond iv) Power point v) Underfloor, telephone & IT vi) Security alarm system <p>All such As-Built drawing and manuals are to be submitted to the Superintending Officer within a reasonable period after the date of completion or expiry of any extended time there of. It shall be a condition precedent to the release of performance bond that the above submissions are accepted by the Superintending Officer.</p>	N/A			
C	<p>DUST PREVENTION</p> <p>The Contractor shall make adequate provision by spraying, erecting screens or other suitable method againts any nuisance or damage by dust to all work under this contract or to persons or property in the vicinity and he will be held solely responsible for any complaints, damage or claims in this connection.</p>	LS			
	Total to Carry Forward				

PRELIMINARIES

Item	Description	Unit	Qty	Rate (RM)	Amount (RM)
A	<p style="text-align: right;">B/F</p> <p>START WORK COMPLIANCE The Contractor shall supply and prepare all the items as noted below before commencing work: a) First Aid Kit b) "Work In Progress" signage in A3 size (To BSN customers and public) (Failure in complying the above requirements will result non admission to the site)</p>	LS			
B	<p>UPON COMPLETION On completion of the works and before handing over, the Contractor shall:</p> <p>(i) Completely remove all debris and rubbish from the building and the whole site including making good all works disturbed.</p> <p>(ii) Remove all paint spots and clean all floors, wall, timber, hardware, glass, glazed tiles, stainless steel and all other surfaces, and leave all same in a dry condition and polished as directed.</p> <p>(iii) Hand over keys of all doors to the S.O. Keys shall have identifying tabs attached.</p> <p>(iv) Ensure that all services and equipments are functioning efficiently and to the approval of the S.O.</p> <p>(v) Clear all drains of obstructions.</p> <p>(vi) Leave the buildings and the ground clean and tidy and ready for immediate operation.</p>	LS			
	Total to Carry Forward				

PRELIMINARIES

Item	Description	Unit	Qty	Rate (RM)	Amount (RM)
A	<p style="text-align: right;">B/F</p> <p>AMPLIFICATION NOTES TO CONDITIONS OF CONTRACT (cont'd)</p> <p>INSURANCE AGAINST PERSONAL INJURIES AND DAMAGE TO PROPERTY</p> <p>The Contractor shall effect and maintain a Contractor's All Risks Policy in the joint names of BANK SIMPANAN NASIONAL the Contractor, their appointed Sub-Contractors and shall arrange the policy with an Insurance Company to be approved by the BANK SIMPANAN NASIONAL and covering particularly the following :</p> <p>i. Third Party Liability (RM25,000.00) on any one accident and unlimited during the period of insurance and the total limit of indemnity is unlimited.</p> <p>ii. Insurane of work to cover the contract of sum plus 10% on any one claim or series of claims arising out of any one event.</p> <p>iii. Injury and damage to property real and personal.</p> <p>iv. Cross Liability.</p> <p>v. Extended Maintenance Cover (for Maintenance Period or Defects Liability Period and an Additional of 45 days Thereafter).</p> <p>vi. Extension of cover of extra-charges for overtime, night work and work on Public Holidays.</p> <p>vii. Automatic reinstatement of sum insured.</p> <p>viii. The insurance policy must be endorsed to cover injury to the SupervisingStaff, the S.O. Superintending Officers, Quantity Surveyors, BANK SIMPANAN NASIONAL and their representatives. No excess Clause shall be specified in the policy or policies in effecting the above.</p>	LS			
	Total to Carry Forward				

PRELIMINARIES

Item	Description	Unit	Qty	Rate (RM)	Amount (RM)
A	<p style="text-align: right;">B/F</p> <p>AMPLIFICATION NOTES TO CONDITIONS OF CONTRACT (cont'd)</p> <p>INSURANCE AGAINST PERSONAL INJURIES AND DAMAGE TO PROPERTY (cont'd)</p> <p>The Contractor will be required to produce all cover notes and receipts for premiums paid in respect of all insurance for the inspection of the S.O before the commencement of any work in this Contract. Period of cover for the insurance shall be the full Contract Period and extended to cover the Defects Liability or Maintenance Period Plus an additional of 45 days.</p> <p>viii. Pay such contribution as have become due and remain unpaid and deduct the amount of such contribution from any money due or to become due to the Contractor.</p> <p>Nothing in this Clause shall be construed to take away or to waive or any manner to modify the right of the BANK SIMPANAN NASIONAL to be indemnified by the contractor in respect of all compensation, cost and other expenses whatsoever which by reason of the Contractor's default or otherwise become payable by the BANK SIMPANAN NASIONAL under the said Legislation or other law.</p>				
B	Stamp duty	LS			
	Total to Carry Forward				

PRELIMINARIES

Item	Description	Unit	Qty	Rate (RM)	Amount (RM)
A	B/F				
	QUALITY ASSESSMENT SYSTEM IN CONSTRUCTION (QLASSIC)				
	Contractor is to note that this Contract shall be carried out based on standards in quality assessment under Quality Assessment System In Construction (Qlassic) schemes. Contractor to allow all sampling and assessment to be in compliance with the Qlassic standards.	N/A	-		
	No claims will be entertained on ground of inadequate information or ignorance with regards to the above requirements.				
	Matrix on Qlassic will be based on the following:				
	0 - 20 Markah - Sangat Tidak Memuaskan				
	21 - 40 Markah - Tidak Memuaskan				
	41 - 60 Markah - Memuaskan				
	61 - 80 Markah - Baik				
	81 - 100 Markah - Cemerlang				
Contractor will be responsible to get Qlassic assessor(s) for assessment and to provide the result to BSN.					
B	Stamp duty	LS			
Total to General Summary					

GENERAL CONDITIONS

	<p><u>GENERAL CONDITIONS</u></p> <p>The tenderer is to note that the estimated quantity listed with this schedule of works are only as a guideline for this tender and DOES NOT form part of the contract. The tenderer shall visit the site, examine the drawings and specification to ascertain the actual nature, character and extent of works. No claim will be entertained on the grounds of ignorance of the conditions under which the works will be carried out.</p> <p>A The tenderer shall thoroughly acquaint himself with all specification clauses before pricing.</p> <p>B The onus is on the tenderer to comply with all the clauses in the specifications and Drawings that apply to the work whether specifically mentioned or not.</p> <p>C The tenderer is required to examine the drawings, visit and inspect the site prior to tendering and acquaint himself with the full extent and character of the work and no claim for variation, alteration or additional payment will at any time be considered or admitted on the grounds of lack of knowledge of the works, lack of information, deficiency of description or occasioned by any default of inspection on the part of the Contractor.</p> <p>D The Contractor shall be responsible for checking all drawings issued to him and if he find discrepancies in the drawing he shall, before proceeding with the works, inform the S.O of such discrepancies.</p> <p>E No claims by the Contractor for any cost incurred as a result of discrepancies in the drawings will be entertained if he fails to inform the S.O of such discrepancies before proceeding with the works.</p> <p>All working drawing shall be made available at site and kept in good condition.</p>				
--	---	--	--	--	--

GENERAL CONDITIONS (cont'd)

	<p><u>GENERAL CONDITIONS (cont'd)</u></p> <p>A The Contractor will have no claim for alleged loss of profit caused by any omission of scope of works by the Client during the construction period.</p> <p>B The tenderer shall note the extent of the demolition works required. The successful Tenderer shall liaise closely with the Project Coordinator with regards to the demolition works.</p> <p>C The Contractor is responsible and shall ensure all the items listed below are in good conditions, operated and ready to be used during work progress: a) Alarm system b) Telephone and fax c) Data line for ATM/CDM and counter d) Fire extinguisher e) Toilet (Failure in maintaining good conditions and operation will result in issuance of stop work order immediately)</p> <p>D The Contractor is to ensure that the physical condition of the site is safe and secure during work progress for BSN staff/customers/public. (Failure in complying the above condition will result in issuance of stop work order immediately)</p> <p>E The Contractor shall before commencing work confirm with the S.O the location for storing of equipments / machineries / materials. The Contractor shall place all their equipments / machineries / materials in a locked storage box if it is located outside BSN premis.</p>				
--	---	--	--	--	--

GENERAL CONDITIONS (cont'd)

	<p><u>GENERAL CONDITIONS (cont'd)</u></p> <p>A All prices are to include for shorting, temporary supports, protective screens and precautionary security measures necessitated by each item and all other costs and charges including making good surrounding works, etc. that may be inferred from each item.</p> <p>B The tenderer shall note that the term 'Demolition' applied herein shall include the hacking up, breaking out, cutting off stanchion, grubbing up and removal of all footings, bases and foundations of the structures to be demolished.</p> <p>C Before commencing demolition to the various of work the tenderer must ensure the stability of the remaining sections and safety of neighbouring properties by providing all necessary shores, supports, underpinning, etc. as the situation dictates. The prices of the works are to include for all these provisions.</p> <p>D The term "S.O/Client" wherever used in the Contract Document shall mean Project Coordinator/Designer from Bank Simpanan Nasional.</p> <p>E Certain areas of the site may be allocated for storing materials and the Contractor is to note that these areas will be strictly adhered to. Materials and goods when found to be stored in unauthorised areas must be immediately removed from site.</p> <p>F Upon receiving any instruction to rectify any defects by the Client, the Contractors shall immediately commence to make good such defects and complete them within the time period given. The Client reserves the right to order additional labour and plant to be deployed during the Defects Liability Period.</p>				
--	--	--	--	--	--

RENOVATION WORK

BANK SIMPANAN NASIONAL

GC/3

GENERAL CONDITIONS (cont'd)

	<p><u>GENERAL CONDITIONS (cont'd)</u></p> <p>SUBMISSION & CONTRIBUTION FEE TO TNB / SESB / SESCO</p> <p>A Contractor shall liaise with TNB for new BSN branch and made necessary arrangement for connection of power supply and application of new meter or DB & made a payment or any contribution fee to TNB. Any claim for submission and contribution fee will be entertain with official receipt from TNB/ SESB/ SESCO.</p>				
--	--	--	--	--	--

RENOVATION WORK

BANK SIMPANAN NASIONAL

BILL OF QUANTITIES

BILL NO.2- RENOVATION WORKS

RENOVATION WORKS

Item	Description	Unit	Qty	Rate (RM)	Amount (RM)
	<p>Note : The tenderer is to take note that the quantity indicated against any item in this Schedule of Works shall be used as a guide only and shall not form part of the contract.</p>				
	<p><u>DEMOLITION WORKS</u></p>				
A	To dismantle / remove existing drywall partition and unnecessary fitting as per S.O's instruction including making good affected area	LS			
	<p><u>SERVER RACK RELOCATION</u></p>				
B	To relocate existing server rack and fixed or mounted to wall at higher level / ceiling level all as per S.O's approval including making good affected area	LS			
	<p><u>NEW WORKS : DRYWALL PARTITION</u></p>				
C	New full height 76mm thick 'Normal Partition' with 12.5mm thick 'Gypsum Board Partiton' both sided finished to underside of ceiling with 51mm metal stud laid 610mm max. centre vertically complete with top and bottom track of partition and all as per manufacturer's instruction and specification and S.O.'s approval including finisher with White Colour painting and approval to general surface to S.O's approval	M2	10		
	<p><u>MAKING GOOD INTERNAL WALL</u></p>				
D	Supply, deliver and install new 900mm x 2100mm high single leaf half glass timber flush door c/w tinted film and completed with aluminium frame to approval including all necessary accessories.	NO	1		
	<p><u>MAKING GOOD INTERNAL WALL</u></p>				
E	To make good and remain existing wall including cleaning and repainting (if necessary) in White Colour and approved to general surface to S.O's approval.	LS			
	<p><u>CARPET</u></p>				
F	To clean & make good existing carpet finishes including all necessary accessories and to S.O's approval	LS			
	<p><u>EXISTING SUSPENDED CEILING</u></p>				
G	To remain and make good existing suspended ceiling for affected area and to S.O's approval	LS			
	<p><u>FURNITURE</u></p>				
	Supply, delivery and place in position furniture and fixture all as per detail drawing and to S.O's approval.				
H	Office Working Chair (BC/3a) - To match existing	No	6		
J	Office Working Table (WT/5a)- To match existing	No	6		
K	Manager Working Chair (BC/2)	No	1		
L	Manager Working Table (WT/2a)	No	1		
M	Pedestal Drawer	No	7		
N	Discussion Chair (DC/3a) - Meeting Room	No	12		
	Total to Carry Forward				

RENOVATION WORKS

Item	Description	Unit	Qty	Rate (RM)	Amount (RM)
	B/F				
	<u>AIR - CONDITIONING</u>				
A	Supply and install Air Conditioning, 'Daikin' brand or other equivalent ,complete with condensing unit, refrigerant piping and drain pipe to be lay above ceiling level c/w proper piping support & bracket for both pipe. Complete inclusive wiring & accesories, interlocking / signal wiring, recharging gas, iron bracket for outdoor, and other necessary accessories subject to S.O approval c/w testing and commisioning. - Unit for 2.0 Hp : Wall Mounted Type	No	1		
B	To service and relocate existing aircond including any other necessary accessories subject to S.O approval c/w complete testing and commisioning.	No	2		
	<u>SWITCH SOCKET OUTLET (SSO)</u>				
C	Supply and install new heavy duty 13 amp surface SSO including halfmoon pvc conduit complete with 1 x 13A or 2 x 13A switch socket outlets to workstation; all as per S.O's instruction and approval	No	18		
D	To rearrange and relocated existng 13 amp SSO including halfmoon pvc conduit to workstation ; all as per S.O's instruction and approval	LS			
	<u>ICT</u>				
E	To supply and install new Category 6 Copper Cable, 23AWG Low Smoke Zero Halogen inclusive of patch panel, RJ-45 Snap-In Modular Jack, Single Port Angled Faceplate, Patch Cords, termination and all other necessary accessories installed cable to be terminated with T568B Colour Coding and must be tested with a Calibrated Cable Certifier complete with tested report for TELEPHONE,DATA, (Brand: Nexans or other equavalent)	No	18		
F	To rearrange and relay existngAMP Cat6 UTP cable including faceplate with PVC conduits & labelling from floor rack to workstation including all necessary and accessories.	LS			
G	To supply and install AMP 24 port Cat6 UTP patch panels with cable management (if necessary)	Nos	1		
	<u>OTHERS</u>				
H	Cleaning & making good existing toilet and pantry including to repair any damages	LS			
J	General cleaning (all area including other office spaces and staircase)	LS			
K	Making good existing door and to ensure all doors in good condition and function (D7). Any other item not specified above but shown in the drawing :-	LS			
L				
M				
	Total to General Summary				

BORANG MAKLUMAT SYARIKAT /COMPANY INFORMATION FORM

1. Latar Belakang Syarikat /Company Background

Nama Syarikat
Company Name

Alamat Perniagaan
Business address

Alamat Surat Menyurat
Mailing address

No. Telefon
Phone No.

No. Faksimili
Facsimile No.

Alamat Email
Email address

Website

Pegawai Untuk Dihubungi
Contact Officer

2. No. Pendaftaran Syarikat
Company Registration No.

3. Lain-lain Pendaftaran
Other Registration

i. No. Kementerian Kewangan
Ministry Of Finance (MOF) No.

ii. No. CIDB

iii.No. PKK

4. Tarikh Penubuhan Syarikat
Date of Establishment Company

5. Jenis Syarikat / Pembekal
Company Type / Supplier

Tunggal /Sole Trader Perkongsian /Partnership

Sendirian Berhad /Private Limited Company

Berhad / Public Limited Company Koperasi /Cooperatives

6. Nama Pemegang Saham
/ Pemilik Syarikat dan
% Saham
*Shareholder Name
/Company Ownership and
% Of Shares*

Nama /Name	% Pemilikan /Ownership

7. Kedudukan Kewangan
Financial Information

i. Modal Berbayar : RM.....
Paid Up Capital

ii. Modal Dibenarkan : RM.....
Authorized Capital

- iii. Penyata Kewangan Akaun Semasa Syarikat 3 Bulan
 Terakhir :
Financial Statement Current Account For Last 3 Months:
 (Sila Sertakan Salinan Asal /*Please Attach Original Copy*)
- iv. Pengesahan Kemudahan Kredit Yang Diperolehi :
Validation of credit facilities obtained:
 (Sila Sertakan Salinan Asal, Jika Ada)
 (*Please Attach Original Copy, If have*)

8. Pengalaman syarikat yang berkaitan dengan bidang kerja /*Company experience related to the field of work;*

- i. Jenis Perniagaan : * _____
Type of business :
 (* contoh : pengilang /*example: manufacturer*)
- ii. Senarai Staf Teknikal /*Technical Staff List*
 (sila kemukakan di **lampiran G** /*Please attach at Appendix G*)
- iii. Senarai Pengalaman Kerja (2 Tahun Terakhir)
List of Work Experience (Last 2 Years)
 (sila kemukakan di **lampiran H** /*Please attach at Appendix H*)
- iv. Senarai Kerja / Projek Ditangan Bagi Tahun Semasa
List of Jobs In Hand For The Current Year
 (sila kemukakan di **lampiran I** /*Please attach at Appendix I*)

9. Maklumat tentang urusan perniagaan di BSN /*Information on business transactions in BSN :*

- i. Akaun BSN GIRO Korporat Ada /Yes Tiada /No
BSN GIRO Corporate Account
- ii. Akaun BSN GIRO Ada /Yes Tiada /No
BSN GIRO Account
- iii. Produk - Produk BSN (Tandakan sekiranya ada)
BSN Products (Tick if any)
- | | | | | |
|--|----------|--------------------------|-----------|--------------------------|
| • BSN Kad Kredit / <i>Credit Card</i> | Ada /Yes | <input type="checkbox"/> | Tiada /No | <input type="checkbox"/> |
| • BSN SSP | Ada /Yes | <input type="checkbox"/> | Tiada /No | <input type="checkbox"/> |
| • BSN Kewangan Mikro / <i>Micro Finance</i> | Ada /Yes | <input type="checkbox"/> | Tiada /No | <input type="checkbox"/> |
| • BSN Term Deposit | Ada /Yes | <input type="checkbox"/> | Tiada /No | <input type="checkbox"/> |
| • BSN SEDAR / CHES | Ada /Yes | <input type="checkbox"/> | Tiada /No | <input type="checkbox"/> |
| • Pinjaman BSN / <i>BSN Loan</i> | | | | |
| ➢ BSN MyRinggit | Ada /Yes | <input type="checkbox"/> | Tiada /No | <input type="checkbox"/> |
| ➢ BSN MyHome | Ada /Yes | <input type="checkbox"/> | Tiada /No | <input type="checkbox"/> |
| ➢ BSN MyAuto | Ada /Yes | <input type="checkbox"/> | Tiada /No | <input type="checkbox"/> |
| • BSN Pengurusan Harta / <i>Wealth Management</i> | | | | |
| ➢ Perlindungan Harta
<i>Wealth Protection</i> | Ada /Yes | <input type="checkbox"/> | Tiada /No | <input type="checkbox"/> |
| ➢ Insurans / <i>Insurance</i> | Ada /Yes | <input type="checkbox"/> | Tiada /No | <input type="checkbox"/> |
| ➢ Pengagihan Harta
<i>Wealth Distribution</i> | Ada /Yes | <input type="checkbox"/> | Tiada /No | <input type="checkbox"/> |
| • Lain – lain (sila nyatakan) / <i>Others (please state)</i> | | | | |

10. Maklumat tentang deklarasi 'connected parties' /*connected parties declaration*

Untuk dilengkapkan oleh syarikat /firma /perkongsian pemohon sahaja, jika berkenaan /To be completed by the applicant company /firm /partnership, if applicable..

Sila tanda pada kotak yang berkenaan /Please tick on the related information.

Ya /Yes atau/or Tidak /No

Saya dengan ini mengisytiharkan bahawa /hereby declare that:

Saya dengan ini mengisytiharkan yang saya mempunyai kaitan dengan Bank Simpanan Nasional seperti berikut: / I am connected to Bank Simpanan Nasional as follows:

..... sebagai pengarah / rakan kongsi / pemilik tunggal / perkongsian / firma mempunyai saudara terdekat yang bertugas sebagai kakitangan di Bank, maklumat adalah seperti berikut:

..... being director(s) / partner(s) / sole proprietor of the applicant company / partnership / firm do have close relatives who is / are staff of the Bank, particulars of which are as follows :

Nama Pihak Berkaitan Name of Connected Party	No. KP / Passport NRIC / Passport No.	Jenis Perhubungan Nature of Relationship

Saya tidak mempunyai sebarang pertalian dengan mana-mana kakitangan, pengarah atau anak syarikat BSN.

I am not related/ connected to any employee, director of BSN or any of its subsidiary.

Tiada ahli keluarga* saya (sama ada secara peribadi atau melalui firma atau syarikat) adalah kontraktor, vendor, pembekal ATAU mempunyai apa-apa urusan niaga komersial, kontrak atau urusan penyumberan luar dengan BSN atau anak syarikatnya. *None of my family member(s)* (either personally or through their firm or company) is a contractor, vendor, supplier or has any commercial transactions, contract or outsourcing dealings with BSN or any of its subsidiaries.*

* 'ahli keluarga' merujuk kepada suami atau isteri, ibubapa, mertua, anak (termasuk anak angkat dan anak tiri) serta menantu, adik-beradik lelaki dan perempuan serta ipar atau mana-mana tanggungan. * 'family members' refers to spouse, parent, parent in-law, child (including adopted child and stepchild), spouse of his child, brother, sister, spouse of brother and sister or any dependents.

Saya berjanji untuk segera memaklumkan kepada Bank secara bertulis tentang apa-apa perubahan dalam data yang diisytiharkan di sini. Saya sedar tentang tanggungjawab saya di bawah undang-undang semasa untuk sebarang maklumat palsu yang dibentangkan dalam perisytiharan ini. *I undertake to immediately inform the Bank in writing of any change in the data declared herein. I am aware of my responsibility under current legislation for any false information presented in this declaration.*

Tandatangan /Signature: _____

BORANG CREDIT ANALYSIS (CA) - LAPORAN BANK / INSTITUSI KEWANGAN MENGENAI KEDUDUKAN KEWANGAN PETENDER.

(Borang ini hendaklah dilengkapkan oleh pihak Bank atau Institusi Kewangan lain dan diserahkan kepada petender untuk disertakan bersama-sama tendernya sekiranya petender mempunyai Kemudahan Kredit dengan Bank/Institusi Kewangan yang berkenaan)

Kepada:
Naib Presiden/Ketua,
Bahagian Perolehan,
Tingkat 14, Wisma BSN
117, Jalan
Ampang
50450 Kuala Lumpur

Nama Petender :
Projek :

- (A) Kemudahan Kredit yang boleh digunakan untuk pelaksanaan Projek:
Kemudahan Kredit yang telah diluluskan dan kemudahan kredit tambahan minimum yang layak diperolehi oleh petender adalah seperti berikut:

Bil.	Bentuk Kemudahan Kredit	Limit	Baki yang telah digunakan (utilised budget) (RM)	Kredit tambahan yang diluluskan (additional credit) (if any) (RM)	Baki yang tinggal daripada yang diluluskan (Unutilised Balance) (RM)
i	Overdraf	RM	RM		RM
ii	Overdraf bercagar		RM		RM
iii	Talian Kredit	RM	RM		RM
iv	Pinjaman Tetap yang akan/layak diperolehi untuk Projek	RM	RM		RM
v	Surat Jaminan Kredit	RM	RM		RM
	Jumlah	RM -	RM -		RM -

- (B) Ulasan-ulasan mengenai kedudukan kewangan dan akaun Petender:

.....
Tandatangan Untuk Dan Bagi Pihak Bank

Nama Bank :
Meteri Bank :

Nama Pegawai :
Jawatan :
Tarikh :

DOKUMEN TAWARAN TEKNIKAL

RUJUKAN: _____

**CADANGAN UBAHSUAI RUANG PEJABAT DI TINGKAT 1
CAWANGAN TANJUNG KARANG, SELANGOR UNTUK BANK
SIMPANAN NASIONAL**

Tarikh Tutup : Sebelum jam 12.00 Tengah hari

**Peti : Peti Tender ()
Bahagian Perolehan
Tingkat 14, Wisma B.S.N. 117, Jalan Ampang,
50450 KUALA LUMPUR.**

SENARAI SEMAK (CADANGAN TAWARAN TEKNIKAL)

Sila tandakan / Bagi Dokumen-dokumen Yang Disertakan.

Bil.	Perkara / Dokumen	Untuk Ditanda Oleh Syarikat	Untuk Ditanda Oleh Jawatankuasa Pembuka Sebutharga
1.	Jadual Tawaran Teknikal – Spesifikasi	<input type="checkbox"/>	<input type="checkbox"/>
2.	Lampiran F – Jadual & Kaedah Pelaksanaan	<input type="checkbox"/>	<input type="checkbox"/>
3.	Lampiran G – Senarai Kakitangan Teknikal	<input type="checkbox"/>	<input type="checkbox"/>
4.	Lampiran H - Senarai Pengalaman Kerja (2 Tahun Terakhir)	<input type="checkbox"/>	<input type="checkbox"/>
5.	Lampiran I – Senarai Kerja / Projek Ditangan Bagi Tahun Semasa	<input type="checkbox"/>	<input type="checkbox"/>
6.	Jadual Pelaksanaan/Perancangan	<input type="checkbox"/>	<input type="checkbox"/>

JADUAL TAWARAN TEKNIKAL (PEMATUHAN)

1. Petender perlu menepati spesifikasi yang diwajibkan seperti yang dinyatakan dalam SPESIFIKASI TEKNIKAL. Cadangan yang tidak menepati spesifikasi yang ditetapkan akan di TOLAK.
2. Petender hendaklah menjawab semua spesifikasi dengan perkataan 'YA' atau 'TIDAK' pada ruangan jadual yang disediakan. Penyebut Harga yang tidak menjawab 'YA' atau 'TIDAK' akan dianggap menjawab 'TIDAK'.
3. Petender mesti menjawab dengan memberi PENERANGAN TERPERINCI di dalam ruangan keterangan / spesifikasi Petender.
4. Setiap spesifikasi teknikal yang dikemukakan MESTI JELAS dan perlu disokong dengan bukti-bukti yang kukuh seperti surat-surat pengesahan daripada prinsipal dan sijil-sijil yang bertauliah sebagai lampiran.
5. Kegagalan Petender memenuhi item-item di atas menyebabkan ia tidak akan dinilai untuk peringkat seterusnya dan ditolak.

Bil.	Perkara	Rujukan Dokumen	Mandatori	Pematuhan (Ya/Tidak)	Sila Nyatakan Spesifikasi Yang Ditawarkan. Sila Jawab Dengan Jelas Dan Terang
1.	Preliminaries				
	A. Removal of rubbish	Rujuk BQ (page SOW/1/1- SO W/1/4)	M		
	B. Dust prevention				
	C. Start work compliance				
	D. Upon completion On completion of the works and before handing over, the Contractor shall: <ul style="list-style-type: none"> <i>i)</i> Completely remove all debris and rubbish from the building and the whole site including making good all works disturbed. <i>ii)</i> Remove all paint spots and clean all floors, wall, timber, hardware, glass, glazed tiles, stainless steel and all other surfaces, and leave all same in a dry condition and polished as directed. <i>iii)</i> Clear all drains of obstructions. <i>iv)</i> Leave the buildings and the ground clean and tidy and ready for immediate operation. 				
	E. Insurance against personal injuries and damage to property				
	F. Stamp duty				
2.	General conditions	Rujuk BQ (page GC/1- GC/4)	M		

Bil.	Perkara	Rujukan Dokumen	Mandatori	Pematuhan (Ya/Tidak)	Sila Nyatakan Spesifikasi Yang Ditawarkan. Sila Jawab Dengan Jelas Dan Terang
4.	FIT-OUT WORKS				
	A. Demolition Dismantle / remove all existing unnecessary	Rujuk BQ (page SOW/2/1)	M		
	B. Make Good Existing Wall (Internal Wall) Paint type provide paint samples for designer approval prior to painting. Before painting the surfaces shall be clean and free from dirt. The surfaces shall repainting to existing painted surfaces is required.	Rujuk BQ (page SOW/2/1)	M		
	C. Carpet To make good existing carpet	Rujuk BQ (page SOW/2/1)	M		
	D. Furniture Provide samples for designer approval to supply. - Working table - Working Chair	Rujuk BQ (page SOW/2/1)	M		
4.	Mechanical and Electrical Works <u>Mechanical</u> The Contractor shall provide all materials and equipment called for in the specifications including the supply of all labour, machinery and tools to carry out the supply, installation, construction and commissioning	Rujuk BQ (page SOW/2/2)	M		

Bil.	Perkara	Rujukan Dokumen	Mandatori	Pematuhan (Ya/Tidak)	Sila Nyatakan Spesifikasi Yang Ditawarkan. Sila Jawab Dengan Jelas Dan Terang
	<p style="text-align: center;">Aircond</p> <ul style="list-style-type: none"> - 'Daikin' brand or other equivalent including all deemed necessary accessories. - 2.0Hp : Wall Mounted type <p><u>Electrical Works & ICT</u> This Contract shall include the supply, delivery, installation, testing, commissioning, service maintenance and making good any defects during Defects Liability Period for the entire Electrical Works which shall be inclusive of the following as well as specified in the Bill of Works and Drawings :-</p> <ul style="list-style-type: none"> a) Electric Cable b) Small Power Points and Switch Socket Outlets c) ICT cable <p>The Contractor shall ensure that all systems are installed up to the point where functional mode is achieved.</p> <p>Swict Socket - Brand : approved by SIRIM /JKR</p>				
5.	Others	Rujuk BQ (page SOW/2/2)	M		

LAMPIRAN F

JADUAL & KAEDAH PELAKSANAAN

JADUAL PELAKSANAAN

BIL.	AKTIVITI	TEMPOH YANG DIAMBIL (DALAM HARI)
1		
2		
3		

* Jadual juga boleh dikemukakan dalam format lain yang mana perlu menunjukkan tempoh yang diambil (dalam hari)

KAEDAH PELAKSANAAN

BIL	KETERANGAN	KAEDAH	Sila Tanda (X) Yang Berkenaan
1		Sendiri	
2		Sub Labour	
3		Sub Trade	
4		Total Sub	

LAMPIRAN G

SENARAI KAKITANGAN TEKNIKAL

	NAMA KAKITANGAN	JAWATAN	KELAYAKAN	BILANGAN TAHUN PENGALAMAN	BILANGAN TAHUN PENGALAMAN DENGAN PENENDER

*Sila lampirkan sijil-sijil yang berkaitan.

LAMPIRAN H

SENARAI PENGALAMAN KERJA (2 TAHUN TERAKHIR)

1. Di BSN;

	NAMA PROJEK	NILAI PROJEK (RM)	TAHUN

2. Di Lain-lain Agensi;

	NAMA PROJEK	AGENSI	NILAI PROJEK (RM)	TAHUN

LAMPIRAN I

SENARAI KERJA / PROJEK DITANGAN BAGI TAHUN SEMASA

	Nama Projek	Agensi yang mengawas projek	Harga (RM)	Tempoh Kontrak	Peratus Kemajuan	Tarikh Siap Sebenar

SENARAI LUKISAN

CADANGAN UBAHSUAI RUANG PEJABAT DI
TINGKAT 1, CAWANGAN TANJUNG KARANG,
SELANGOR UNTUK BANK SIMPANAN NASIONAL



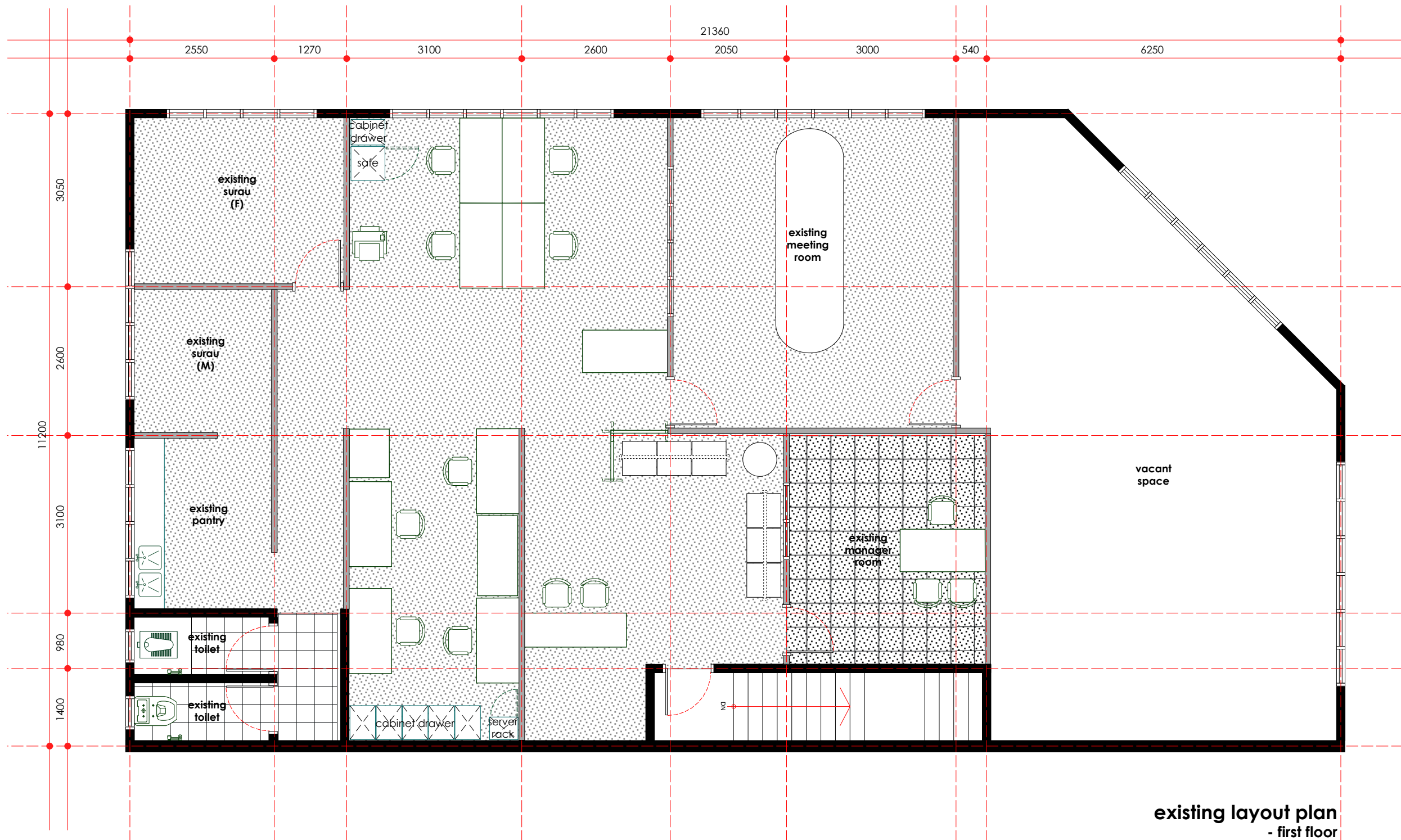

JABATAN PERKHIDMATAN AM &
KESELAMATAN DALAMAN,
TINGKAT 12, WISMA BSN,
117 JALAN AMPANG,
50450 KUALA LUMPUR.
TEL : 03-2162 3222
FAX : 03-2164 6367



existing layout plan
- first floor
scale 1:75

LEGEND:-

Floor Finishing

-  existing carpet tile
-  existing carpet roll (needle punch)
-  existing homogenous tile

Projek	Disemak	Disahkan	Dipersetujui	Diluluskan	Maklumat Lukisan		
					Tajuk Lukisan	EXISTING LAYOUT PLAN - First Floor	
 BAHAGIAN PEMBANGUNAN FASILITI JABATAN PERKHIDMATAN AM & KESELAMATAN DALAMAN	CADANGAN UBAHSUAI RUANG PEJABAT DI TINGKAT 1, CAWANGAN TANJUNG KARANG, SELANGOR UNTUK BANK SIMPANAN NASIONAL	-----	-----	-----	Dilukis oleh	MG	
		Tarikh :	Pengarah Negeri Selangor	Naib Presiden/Ketua Perbankan Runcit	Naib Presiden Kanan/Ketua Perkhidmatan Am & Keselamatan Dalaman	Skala	AS SHOWN
						Tarikh	June 2021
						No.Lukisan	
						Pindaan	1 11 111 IV V VI
						Tarikh	

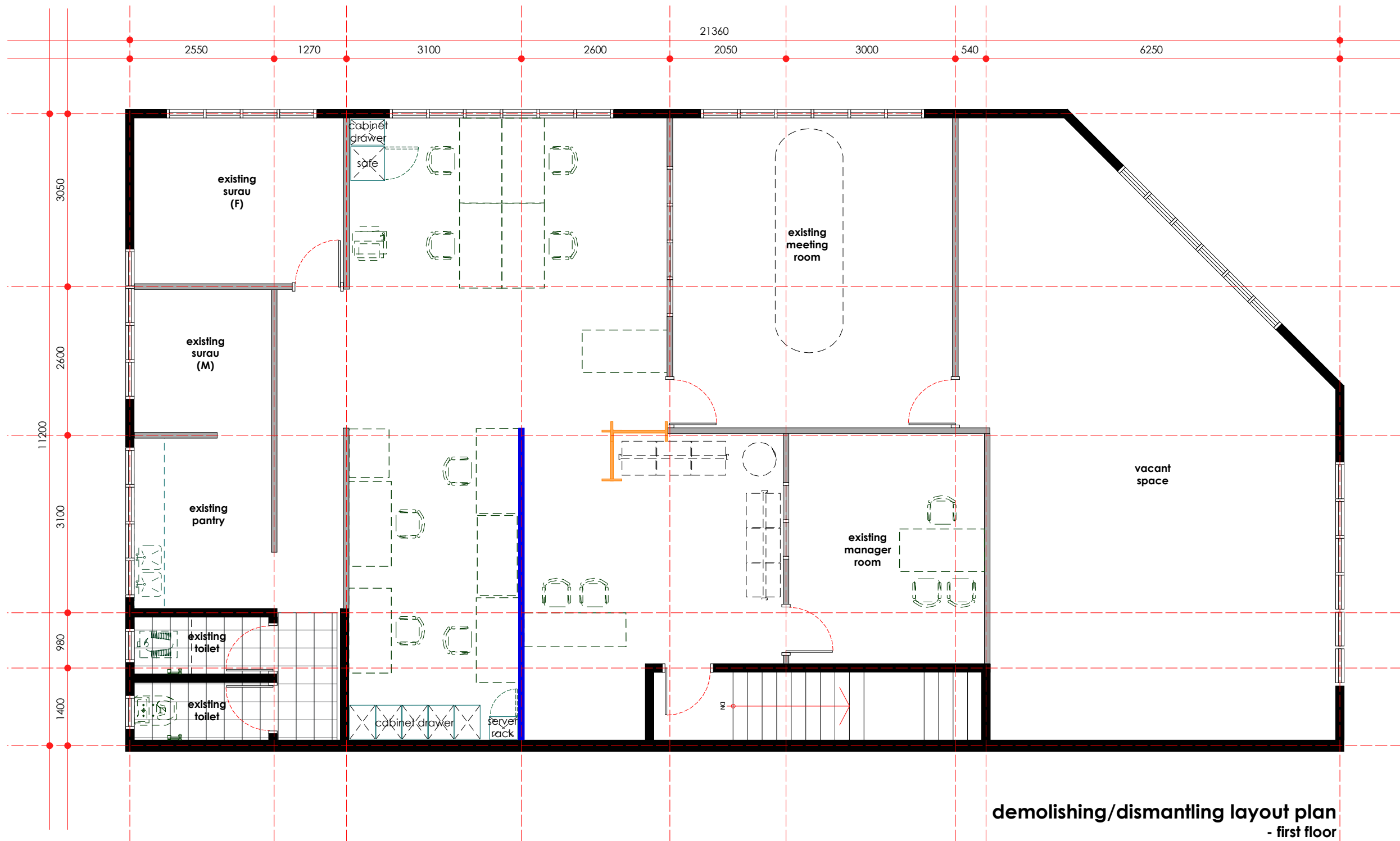

- LEGEND:-**
- existing gypsum wall partition to be demolish and make good all debris work (ceiling/wall/floor) to approval.
 - existing fabric partition panel to be dismantla (ceiling/wall/floor) to approval.

demolishing/dismantling layout plan
- first floor
scale 1: 75

Projek	Disemak	Disahkan	Dipersetujui	Diluluskan	Maklumat Lukisan						
					Tajuk Lukisan	Dilukis oleh	Skala	Tarikh	No.Lukisan	Pindaan	Tarikh
 CADANGAN UBAHSUAI RUANG PEJABAT DI TINGKAT 1, CAWANGAN TANJUNG KARANG, SELANGOR UNTUK BANK SIMPANAN NASIONAL	<p>-----</p> <p>Tarikh :</p>	<p>-----</p> <p>Pengarah Negeri Selangor</p> <p>Tarikh :</p>	<p>-----</p> <p>Naib Presiden/Ketua Perbankan Runcit</p> <p>Tarikh :</p>	<p>-----</p> <p>Naib Presiden Kanan/Ketua Perkhidmatan Am & Keselamatan Dalamam</p> <p>Tarikh :</p>	Tajuk Lukisan	DEMOLISHING/DISMANTLING LAYOUT PLAN - First Floor					
					Dilukis oleh	MG					
					Skala	AS SHOWN					
					Tarikh	June 2021					
					No.Lukisan						
					Pindaan	1	11	111	1V	V	VI
					Tarikh						

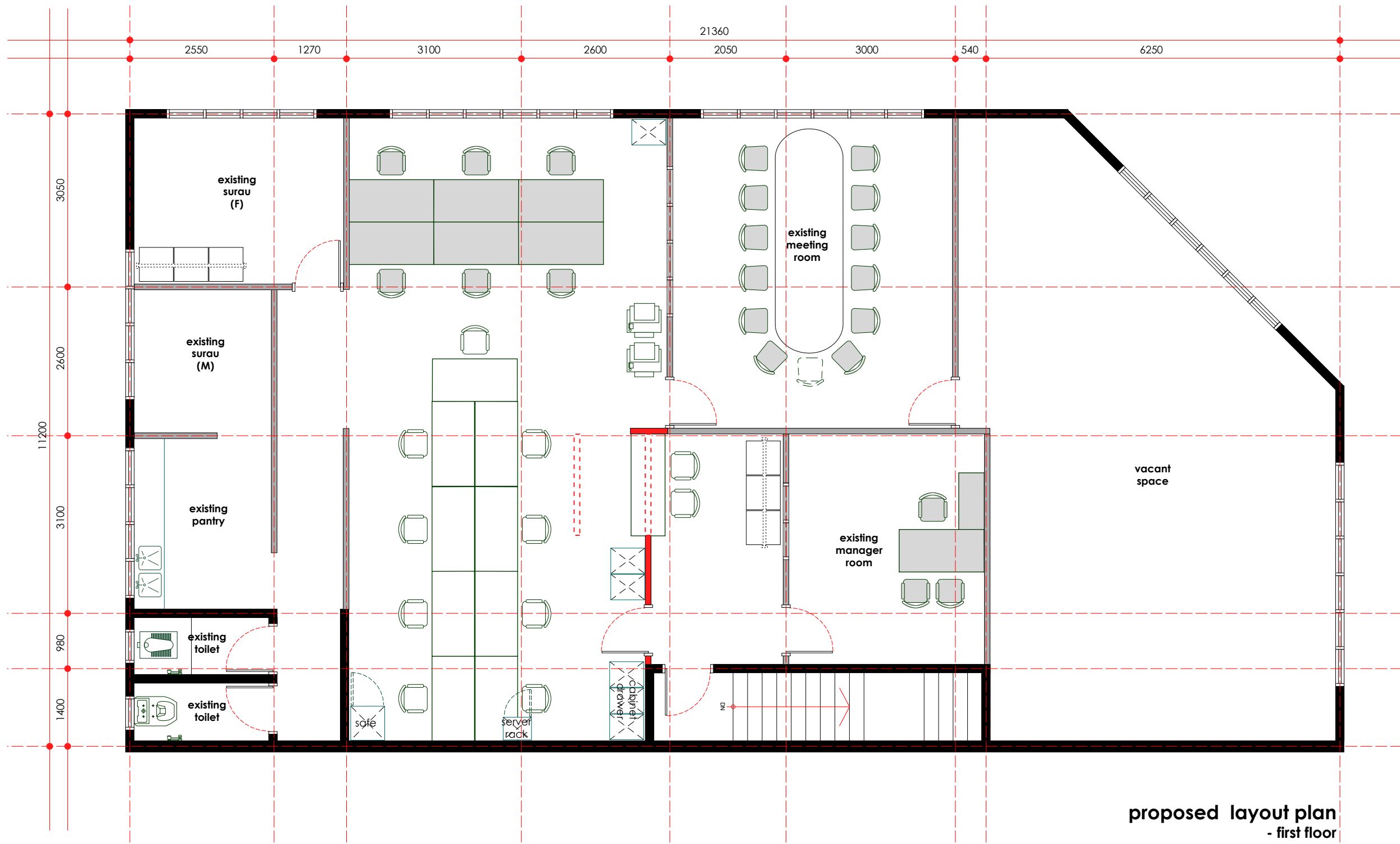

proposed layout plan
- first floor
scale 1: 75

Projek	Disemak	Disahkan	Dipersetujui	Diluluskan	Maklumat Lukisan						
					Tajuk Lukisan	Dilukis oleh	Skala	Tarikh	No.Lukisan	Pindaan	Tarikh
 CADANGAN UBAHSUAI RUANG PEJABAT DI TINGKAT 1, CAWANGAN TANJUNG KARANG, SELANGOR UNTUK BANK SIMPANAN NASIONAL	Tarikh : _____	Pengarah Negeri Selangor Tarikh : _____	Naib Presiden/Ketua Perbankan Runcit Tarikh : _____	Naib Presiden Kanan/Ketua Perkhidmatan Am & Keselamatan Dalaman Tarikh : _____	PROPOSED LAYOUT PLAN - First Floor						
					MG	AS SHOWN	June 2021				
					Pindaan	1	11	111	1V	V	V1
					Tarikh						

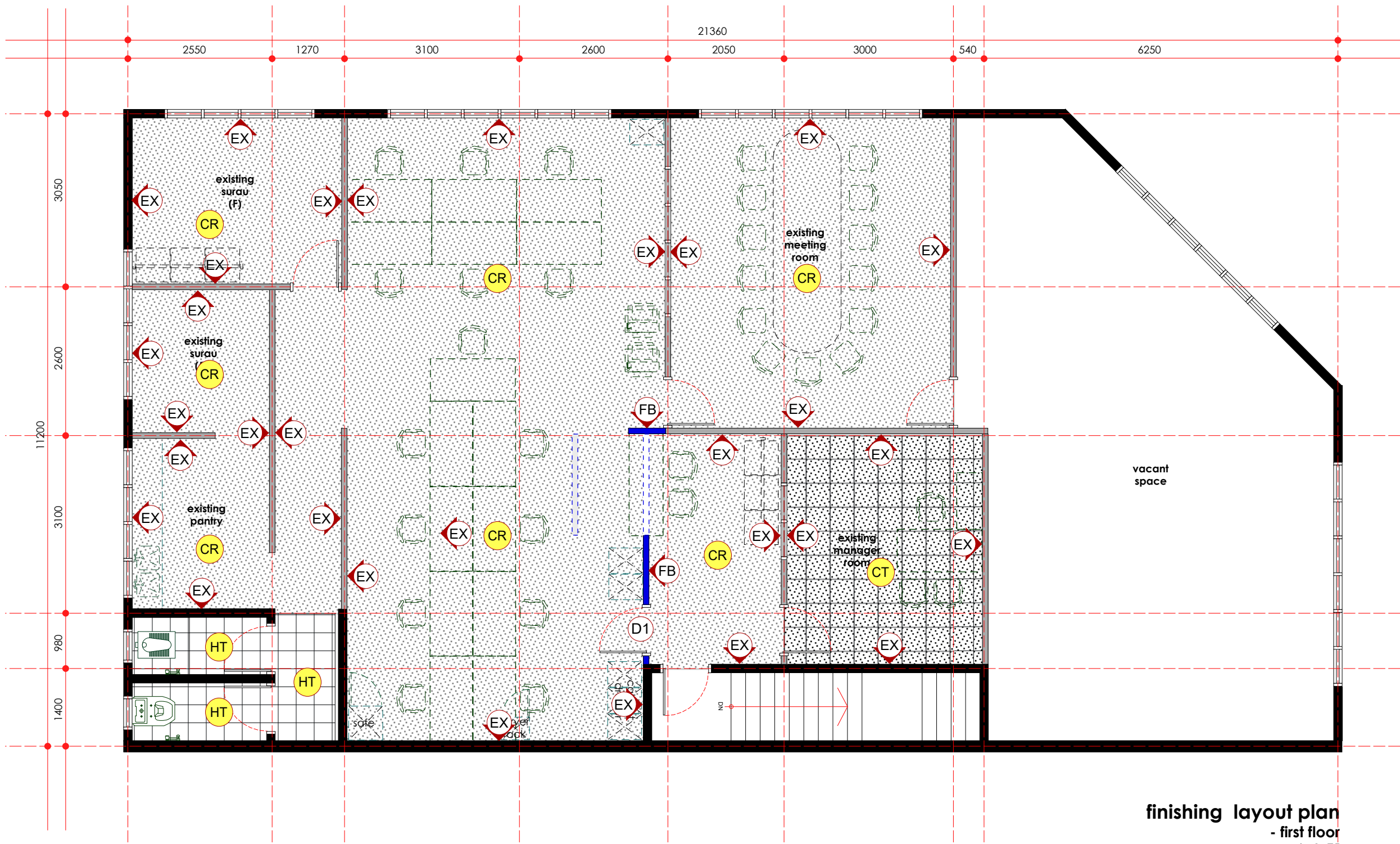

- LEGEND:-**
- existing carpet tile to make good finish to approval.
 - existing carpet roll (needle punch) to be remain with make good finish & replace any debris to approval.
 - existing homogenous tile to re-cleaning to approval.
 - existing wall to be touch-up paint at effected area to approval.
 - 75mm thk gypsum partition c/w all necessary accessories works to be paint finish to approval.
 - new 900mm x 2100mm ht single leaf half glass timber flush door c/w all necessary accessories to approval.
 - existing to be make good all the debris works and re-paint if necessary to approval.

Projek	Disemak	Disahkan	Dipersetujui	Diluluskan	Maklumat Lukisan
<p>CADANGAN UBAHSUAI RUANG PEJABAT DI TINGKAT 1, CAWANGAN TANJUNG KARANG, SELANGOR UNTUK BANK SIMPANAN NASIONAL</p>					Tajuk Lukisan FINISHING LAYOUT PLAN - First Floor
					Dilukis oleh MG
					Skala AS SHOWN
					Tarikh June 2021
					No.Lukisan
					Pindaan 1 11 111 IV V V1
					Tarikh
	Tarikh :	Pengarah Negeri Selangor Tarikh :	Naib Presiden/Ketua Perbankan Runcit Tarikh :	Naib Presiden Kanan/Ketua Perkhidmatan Am & Keselamatan Dalamam Tarikh :	

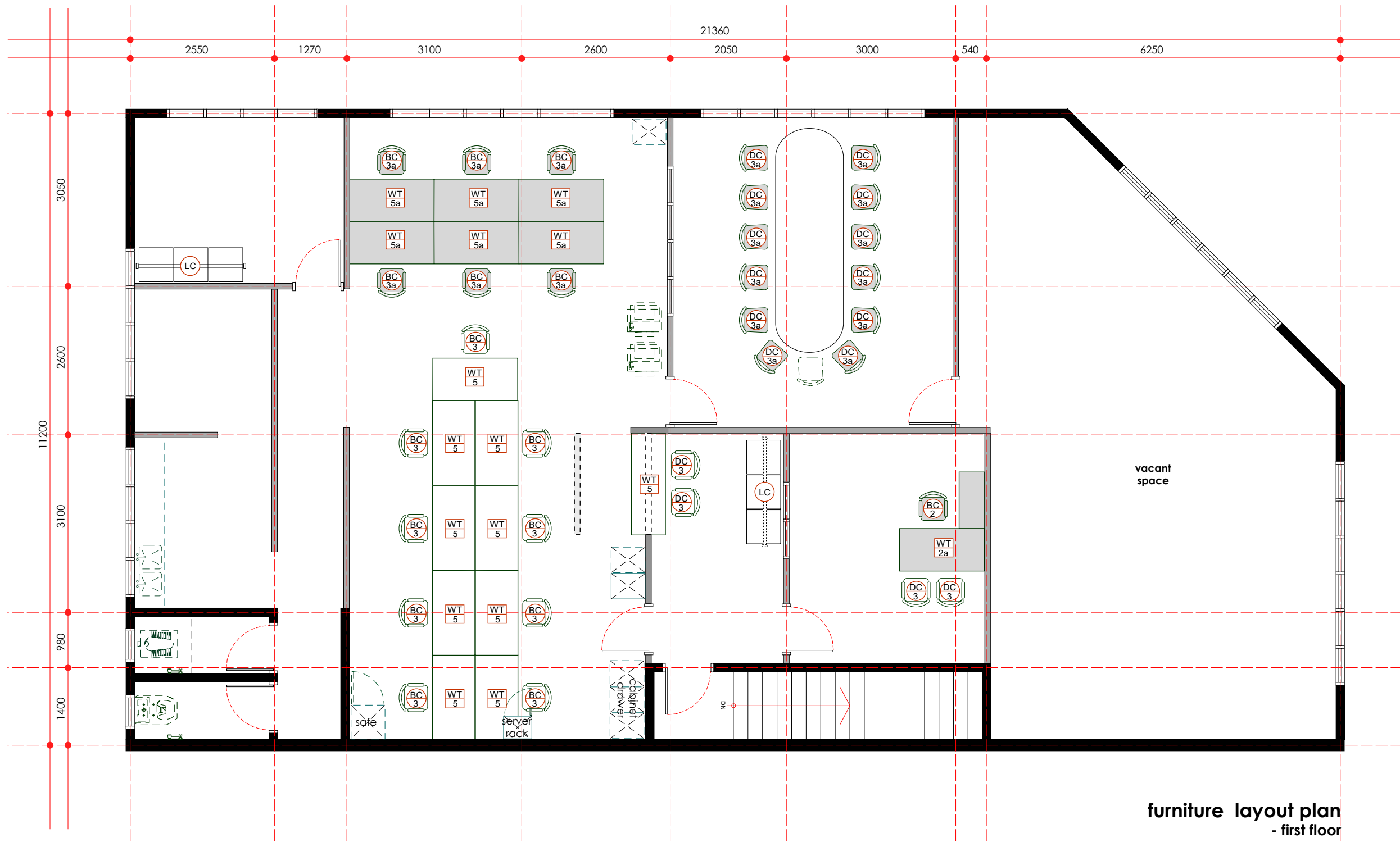

furniture layout plan
- first floor
scale 1: 75







WORKSTATION/TABLE

WT 2a	MANAGER & HOS WORKING TABLE SPEC :MAPLE/MAHOGANY FINISH (TOP) (REFER FURNITURE SCHEDULE)
WT 5	RE-USED EXISTING WORKSTATION /TABLE AND REPLACE ANY DAMAGES TO APP.
WT 5a	OFFICER WORKING TABLE SPEC :MATCH TO EXISTING (1200MM HT - PANEL PARTITION)

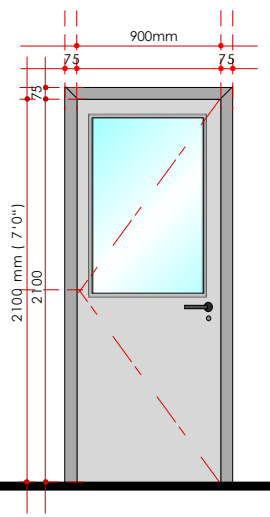
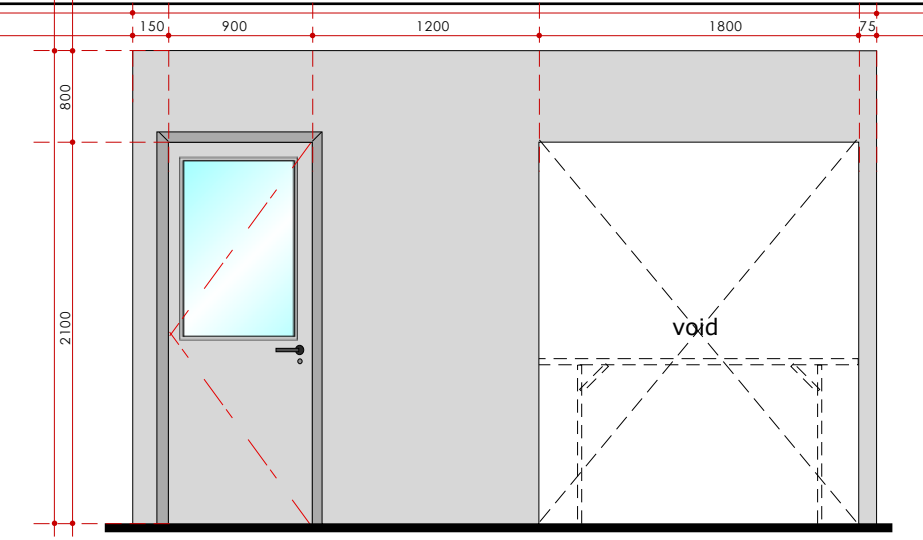
CHAIRS

BC 2	MANAGER & HOS WORKING CHAIR SPEC :KIMMARK - NATURA 2012 (REFER FURNITURE SCHEDULE)
BC 3	RE-USED EXISTING WORKING CHAIR AND REPLACE/REPAIR ANY DAMAGES TO APP.
BC 3a	OFFICER/CLERICAL WORKING CHAIR SPEC :MATCH TO EXISTING (REFER FURNITURE SCHEDULE)
DC 3	RE-USED EXISTING WORKING CHAIR AND REPLACE/REPAIR ANY DAMAGES TO APP.
DC 3a	DISCUSSION/MEETING CHAIR SPEC :MATCH TO EXISTING (REFER FURNITURE SCHEDULE)
LC	RE-USED EXISTING LINK CHAIR TO APP.

Projek	Disemak	Disahkan	Dipersetujui	Diluluskan	Maklumat Lukisan	
 <p>CADANGAN UBAHSUAI RUANG PEJABAT DI TINGKAT 1, CAWANGAN TANJUNG KARANG, SELANGOR UNTUK BANK SIMPANAN NASIONAL</p>	<p>Tarikh :</p>	<p>Pengarah Negeri Selangor</p> <p>Tarikh :</p>	<p>Naib Presiden/Ketua Perbankan Runcit</p> <p>Tarikh :</p>	<p>Naib Presiden Kanan/Ketua Perkhidmatan Am & Keselamatan Dalaman</p> <p>Tarikh :</p>	Tajuk Lukisan FURNITURE LAYOUT PLAN - First Floor	
					Dilukis oleh MG	
					Skala AS SHOWN	
					Tarikh June 2021	
					No.Lukisan	
					Pindaan	1
Tarikh						

				
CODE	D1	FB		BC/2
AREA	REFER DRAWING	REFER DRAWING		REFER DRAWING
DESCRIPTION	900mm X 2100mm HT. 38mmTHK. SINGLE LEAF HALF GLASS TIMBER FLUSH DOOR TO BE PAINT FINISH C/W 5MM THK. CLEAR GLASS AND ALL NECESSARY ACCESSORIES TO APP.	75MM THK GYPSUM PARTITION WALL C/W ALL NECESSARY ACCESSORIES WORKS TO BE PAINT FINISH APPROVAL.		
IRONMONGERY	DOOR CLOSER : DORMA - TS 83 LOCKSET LIVER HANDLE: DORMA - ZS 8111			
				
CODE	WT/2a	WT/5a	BC/3a	DC/3a
AREA	REFER DRAWING	REFER DRAWING	REFER DRAWING	REFER DRAWING
DESCRIPTION	TO MATCH EXISTING (COLOR/SYSTEM/DESIGN) including pedestal drawer	TO MATCH EXISTING (COLOR/SYSTEM/DESIGN) including pedestal drawer	TO MATCH EXISTING (COLOR/SYSTEM/DESIGN)	TO MATCH EXISTING (COLOR/SYSTEM/DESIGN)

 BAHAGIAN PEMBANGUNAN FASILITI JABATAN PERKHIDMATAN AM & KESELAMATAN DALAMAN	Projek	Disemak	Disahkan	Dipersetujui	Diluluskan	Maklumat Lukisan													
	CADANGAN UBAHSUAI RUANG PEJABAT DI TINGKAT 1, CAWANGAN TANJUNG KARANG, SELANGOR UNTUK BANK SIMPANAN NASIONAL					Tajuk Lukisan SCHEDULE													
						Dilukis oleh MG													
						Skala AS SHOWN													
						Tarikh June 2021													
						No.Lukisan													
						<table border="1"> <tr> <td>Pindaan</td> <td>1</td> <td>11</td> <td>111</td> <td>1V</td> <td>V</td> <td>V1</td> </tr> <tr> <td>Tarikh</td> <td></td> <td></td> <td></td> <td></td> <td></td> <td></td> </tr> </table>	Pindaan	1	11	111	1V	V	V1	Tarikh					
Pindaan	1	11	111	1V	V	V1													
Tarikh																			

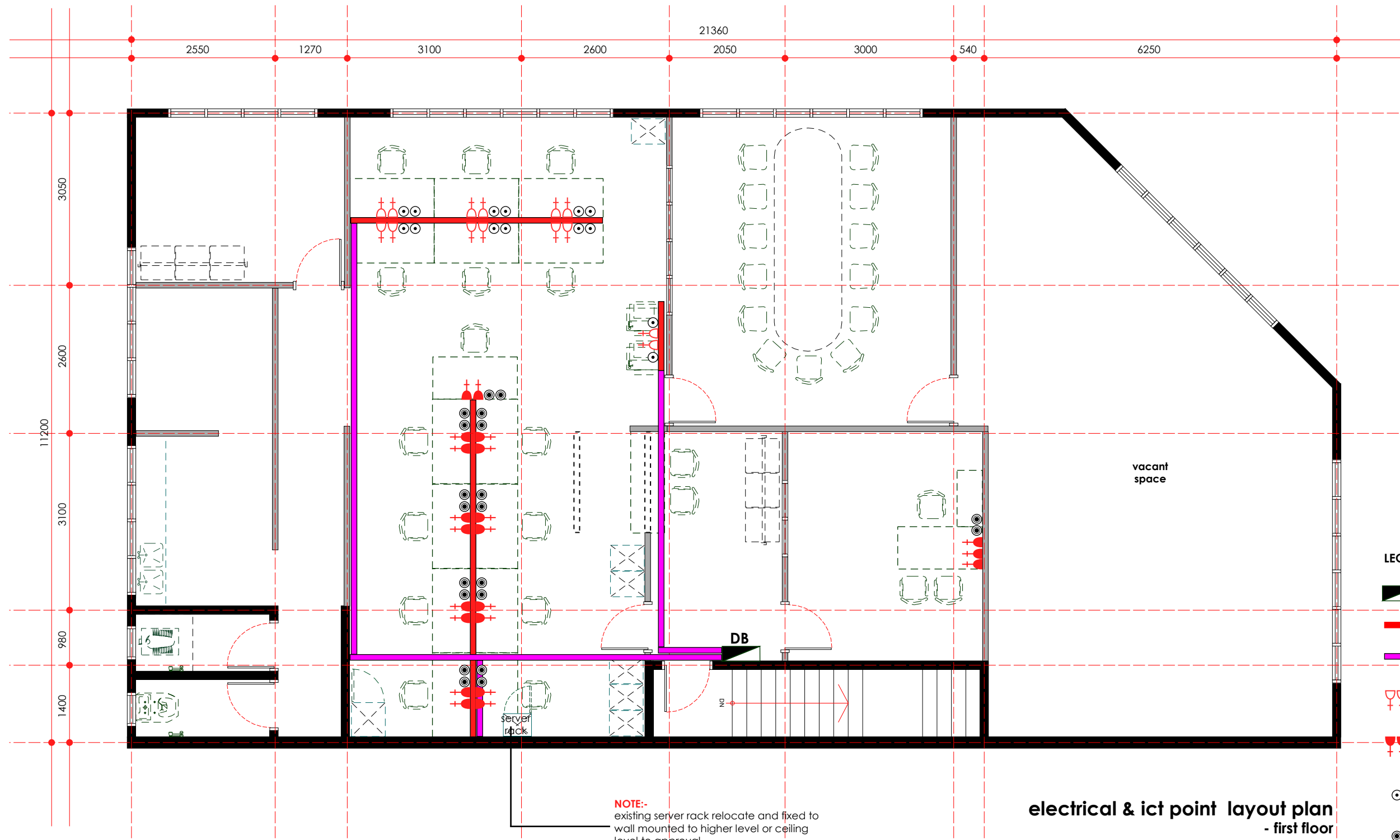

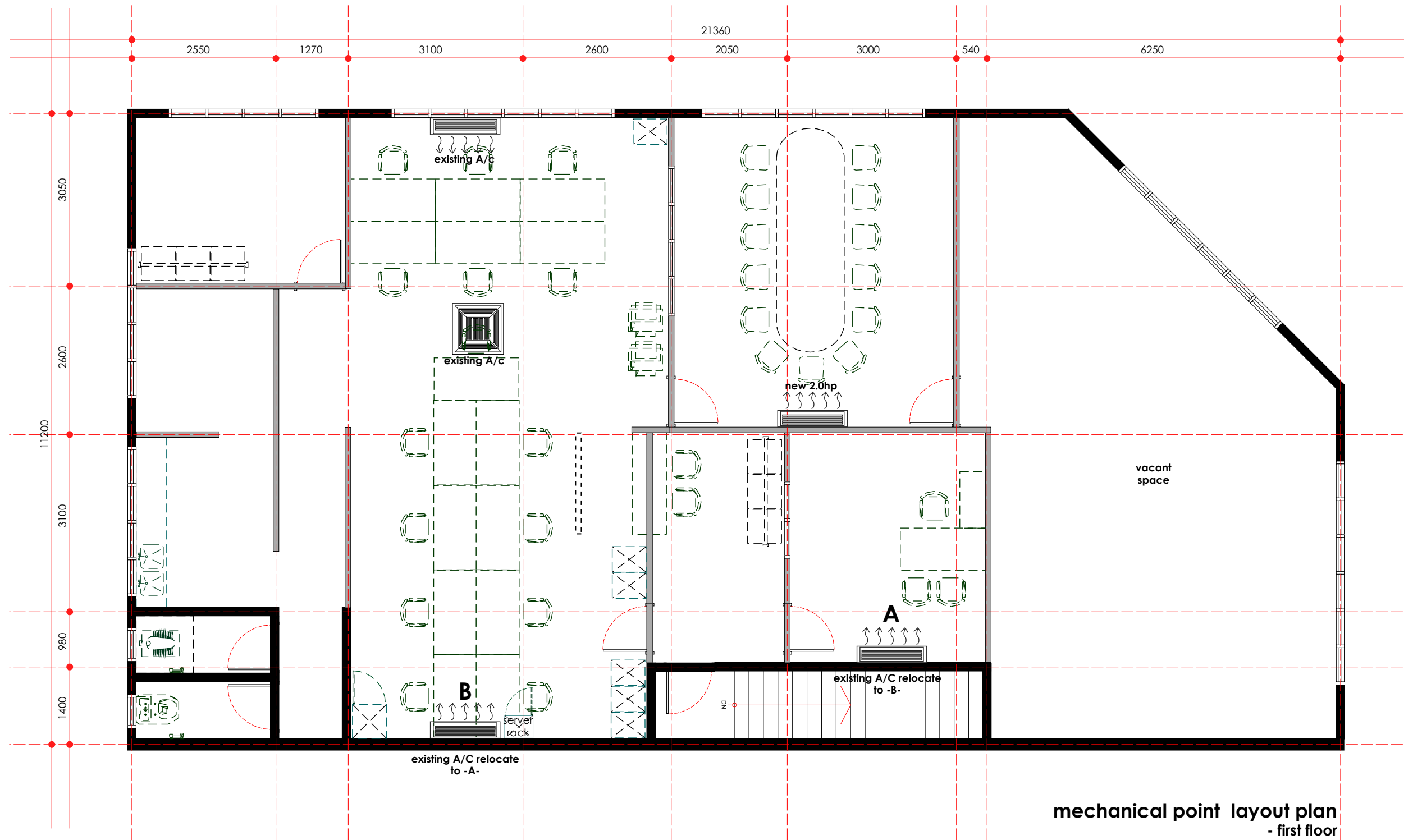

Projek	Disemak	Disahkan	Dipersetujui	Diluluskan	Maklumat Lukisan	
 <p>CADANGAN UBAHSUAI RUANG PEJABAT DI TINGKAT 1, CAWANGAN TANJUNG KARANG, SELANGOR UNTUK BANK SIMPANAN NASIONAL</p>					Tajuk Lukisan: ELECTRICAL & ICT POINT LAY-OUT PLAN - First Floor	
					Dilukis oleh: MG	
						Skala: AS SHOWN
						Tarikh: June 2021
						No.Lukisan:
						Pindaan: 1 11 111 1V V V1
	Tarikh :	Tarikh :	Tarikh :	Tarikh :	Tarikh :	

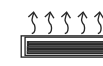

mechanical point layout plan
- first floor
scale 1: 75

LEGEND:-

-  Cassette Type Air Conditioning (Existing)
-  Wall mounted Type Air Conditioning (Existing/New)

Projek	Disemak	Disahkan	Dipersetujui	Diluluskan	Maklumat Lukisan	
 <p>CADANGAN UBAHSUAI RUANG PEJABAT DI TINGKAT 1, CAWANGAN TANJUNG KARANG, SELANGOR UNTUK BANK SIMPANAN NASIONAL</p>					Tajuk Lukisan MECHANICAL POINT LAYOUT PLAN - First Floor	
					Dilukis oleh MG	
						Skala AS SHOWN
						Tarikh June 2021
						No.Lukisan
						Pindaan 1 11 111 1V V V1
	Tarikh :	Tarikh :	Tarikh :	Tarikh :	Tarikh	

ZONE/AREA	ITEM/DESCRIPTION	CODE
BACK OFFICE	WORKING TABLE	WT/2a

MEASUREMENT	IMAGE/SAMPLE
-------------	--------------

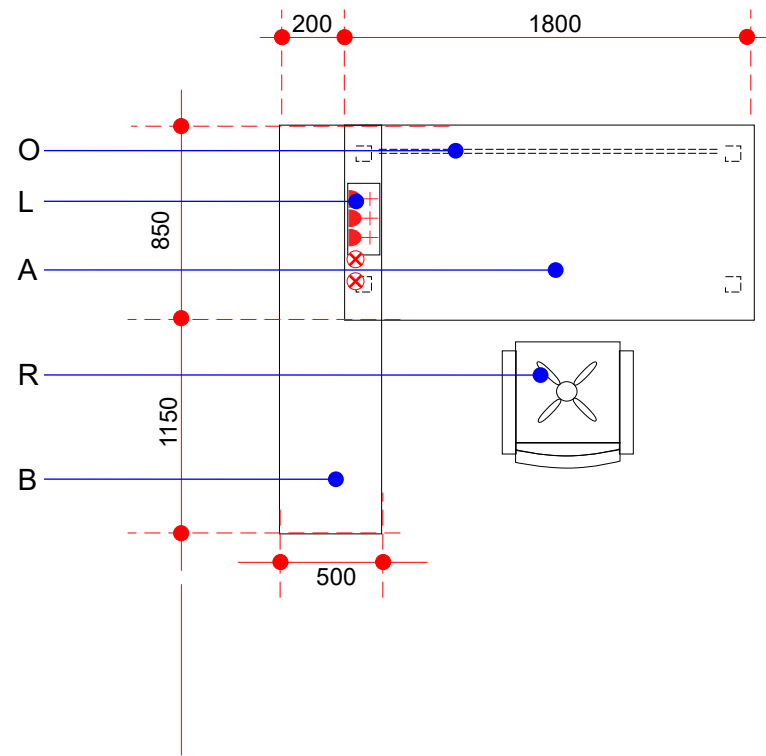

LEGEND	
(A)	WORKING TABLE
(B)	SIDE RETURN
(C)	PEDESTAL DRAWER
(D)	LEATHER PAD
(L)	CABLE MANAGEMENT PANEL
(M)	CPU HOLDER
(O)	BOTTOM PANEL
(R)	HIGH BACK CHAIR
+	PLUG POINT
▼	TELEPHONE LINE
⊗	LAN



COLOR CODE/SAMPLE MATERIAL	QUANTITY
----------------------------	----------

TBC

REFER BILL OF QUANTITY (BQ)

SPECIFICATION	LOCATION
---------------	----------

TBC

MANAGER / HOO ROOM

	Projek	Disemak	Disahkan	Dipersetujui	Diluluskan	Maklumat Lukisan	
 <p>BAHAGIAN PEMBANGUNAN FASILITI JABATAN PERKHIDMATAN AM & KESELAMATAN DALAMAN</p>	<p>CADANGAN UBAHSUAI RUANG PEJABAT DI TINGKAT 1, CAWANGAN TANJUNG KARANG, SELANGOR UNTUK BANK SIMPANAN NASIONAL</p>					Tajuk Lukisan WT/2a	
						Dilukis oleh MG	
							Skala AS SHOWN
							Tarikh June 2021
							No.Lukisan
							Pindaan 1 11 111 1V V VI
							Tarikh



ZONE/AREA

BACK OFFICE

ITEM/DESCRIPTION

WORKING TABLE

CODE

WT/5a

MEASUREMENT

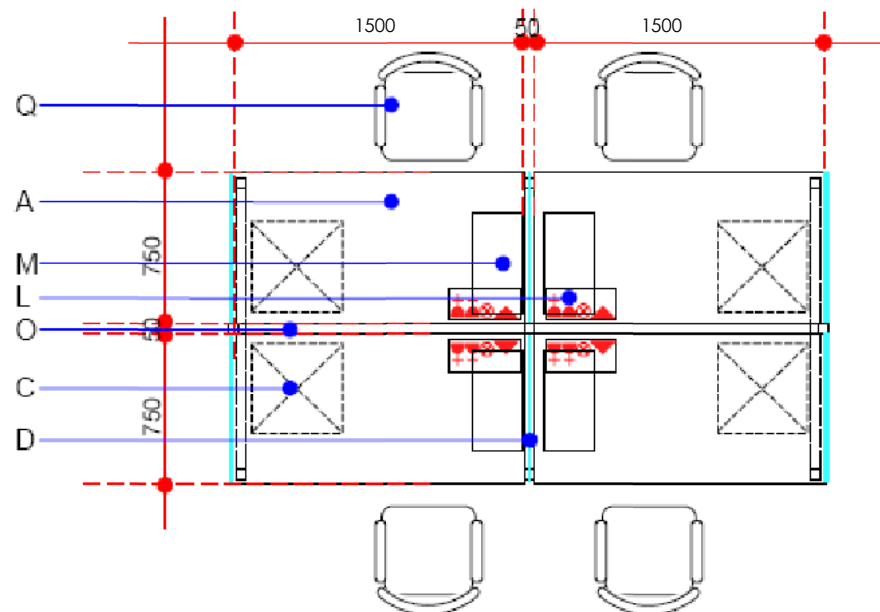

LEGEND	
(A)	WORKING TABLE
(B)	SIDE RETURN
(C)	PEDESTAL DRAWER
(D)	ACRYLIC DIVIDER PANEL
(L)	CABLE MANAGEMENT PANEL
(M)	CPU HOLDER
(O)	FABRIC & BOTTOM PANEL
(Q)	LOW BACK CHAIR
(R)	MEDIUM BACK CHAIR
+	PLUG POINT
▼	TELEPHONE LINE
⊗	LAN

IMAGE/SAMPLE



COLOR CODE/SAMPLE MATERIAL

TBA

QUANTITY

REFER BILL OF QUANTITY (BQ)

SPECIFICATION

TBA

LOCATION

STAFF AREA

	Projek	Disemak	Disahkan	Dipersetujui	Diluluskan	Maklumat Lukisan	
<p>BAHAGIAN PEMBANGUNAN FASILITI JABATAN PERKHIDMATAN AM & KESELAMATAN DALAMAN</p>	<p>CADANGAN UBAHSUAI RUANG PEJABAT DI TINGKAT 1, CAWANGAN TANJUNG KARANG, SELANGOR UNTUK BANK SIMPANAN NASIONAL</p>	-----	-----	-----	-----	Tajuk Lukisan WT/5a	
		Tarikh :	Tarikh :	Tarikh :	Tarikh :	Dilukis oleh MG	
							Skala AS SHOWN
							Tarikh June 2021
							No.Lukisan
							Pindaan 1 11 111 1V V V1
							Tarikh

ZONE/AREA

ITEM/DESCRIPTION

CODE

BACK OFFICE

WORKING CHAIR

BC/2

MEASUREMENT

IMAGE/SAMPLE



COLOR CODE/SAMPLE MATERIAL

QUANTITY

DESIGN : DESIGNERS CHAIR
COLOUR : TO BE SELECTED

REFER BILL OF QUANTITY (BQ)

SPECIFICATION

LOCATION

- DIE CASTING ARMREST, FRAME & STAR BASE MECHANISM
- BLACK LEATHER TO DESIGNERS APPROVAL
- HIGH POLISHED AND CHROME CASTOR
- HIGH BACK CHAIR

MANAGER / HOS ROOM

*READY MADE - TO BE DESIGNERS APPROVAL.

	Projek	Disemak	Disahkan	Dipersetujui	Diluluskan	Maklumat Lukisan
 <p>BAHAGIAN PEMBANGUNAN FASILITI JABATAN PERKHIDMATAN AM & KESELAMATAN DALAMAN</p>	CADANGAN UBAHSUAI RUANG PEJABAT DI TINGKAT 1, CAWANGAN TANJUNG KARANG, SELANGOR UNTUK BANK SIMPANAN NASIONAL	----- Tarikh :	----- Pengarah Negeri Selangor Tarikh :	----- Naib Presiden/Ketua Perbankan Runcit Tarikh :	----- Naib Presiden Kanan/Ketua Perkhidmatan Am & Keselamatan Dalaman Tarikh :	Tajuk Lukisan BC/2
		Dilukis oleh MG				
		Skala AS SHOWN				
		Tarikh June 2021				
		No.Lukisan				
		Pindaan	1	11	111	1V
Tarikh						

ZONE/AREA

ITEM/DESCRIPTION

CODE

BACK OFFICE

WORKING CHAIR

BC/3a

MEASUREMENT

IMAGE/SAMPLE

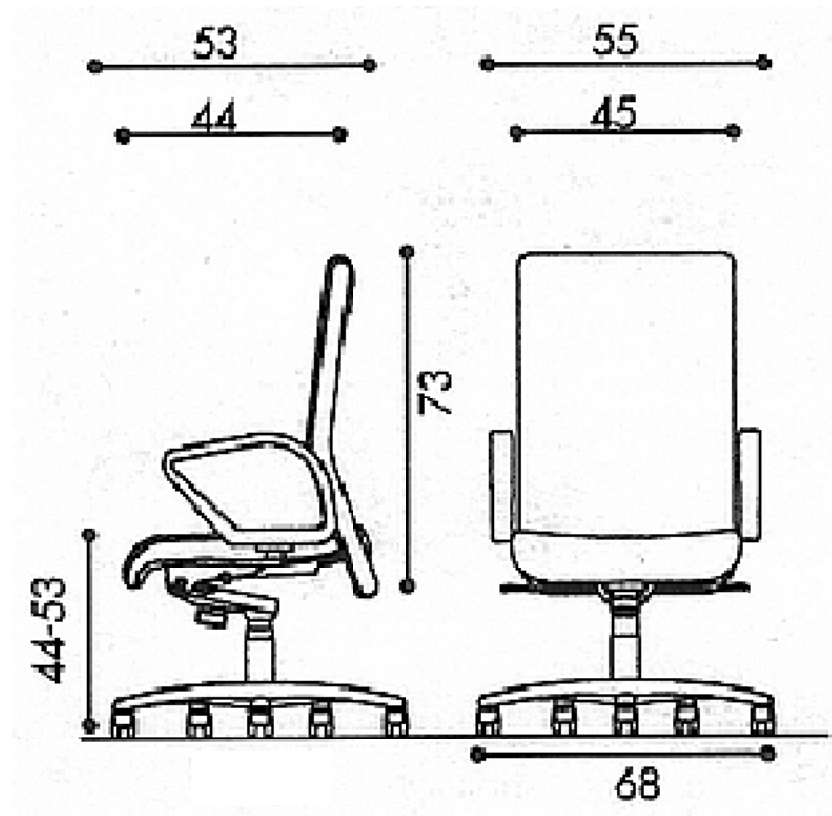

COLOR CODE/SAMPLE MATERIAL

QUANTITY



COLOR AND FABRIC : TO BE SELECTED

REFER BILL OF QUANTITY (BQ)

SPECIFICATION

LOCATION

- MEDIUM BACK CHAIR
- KNEEL TILT MECHANISM AND ADJUSTABLE LIFTING SYSTEM
- HEAVY DUTY PLASTIC CASTOR WITH CHROME FRAME STAR BASE
- ADJUSTABLE ARMREST TO APPROVAL.

EXEC & OFFICER AREA

*READY MADE - TO BE DESIGNERS APPROVAL.

	Projek	Disemak	Disahkan	Dipersetujui	Diluluskan	Maklumat Lukisan	
 <p>BAHAGIAN PEMBANGUNAN FASILITI JABATAN PERKHIDMATAN AM & KESELAMATAN DALAMAN</p>	<p>CADANGAN UBAHSUAI RUANG PEJABAT DI TINGKAT 1, CAWANGAN TANJUNG KARANG, SELANGOR UNTUK BANK SIMPANAN NASIONAL</p>					Tajuk Lukisan BC/3a	
						Dilukis oleh MG	
							Skala AS SHOWN
							Tarikh June 2021
							No.Lukisan
							Pindaan 1 11 111 1V V V1
							Tarikh
		Tarikh :	Pengarah Negeri Selangor Tarikh :	Naib Presiden/Ketua Perbankan Runcit Tarikh :	Naib Presiden Kanan/Ketua Perkhidmatan Am & Keselamatan Dalaman Tarikh :		

ZONE/AREA

ITEM/DESCRIPTION

CODE

BACK OFFICE

DISCUSSION CHAIR

DC/3a

MEASUREMENT

IMAGE/SAMPLE



COLOR CODE/SAMPLE MATERIAL

QUANTITY

DESIGN : DESIGNERS CHAIR
COLOUR : TO BE SELECTED

REFER BILL OF QUANTITY (BQ)

SPECIFICATION

LOCATION

- DIE CASTING ARMREST, FRAME & STAR BASE MECHANISM
- HIGH POLISHED AND CHROME FRAME/LEG
- LOW BACK CHAIR

MEETING/DISCUSSION ROOM

*READY MADE - TO BE DESIGNERS APP

	Projek	Disemak	Disahkan	Dipersetujui	Diluluskan	Maklumat Lukisan
 <p>BAHAGIAN PEMBANGUNAN FASILITI JABATAN PERKHIDMATAN AM & KESELAMATAN DALAMAN</p>	CADANGAN UBAHSUAI RUANG PEJABAT DI TINGKAT 1, CAWANGAN TANJUNG KARANG, SELANGOR UNTUK BANK SIMPANAN NASIONAL	-----	-----	-----	-----	Tajuk Lukisan DC/3a
		Tarikh :	Pengarah Negeri Selangor	Naib Presiden/Ketua Perbankan Runcit	Naib Presiden Kanan/Ketua Perkhidmatan Am & Keselamatan Dalaman	Dilukis oleh MG
						Skala AS SHOWN
						Tarikh June 2021
						No.Lukisan
						Tarikh
					Pindaan	
					Tarikh	